

KENWOOD

UD COMPONENT SYSTEM/COMPACT HI-FI SYSTEM

UD-100

INSTRUCTION MANUAL

KENWOOD CORPORATION



B60-0597-00 (JA) (K,E,T,M,X,Y) [A]
92/12 11 10 9 8 7 6 5 4 3 2 1 91/12 11 10 9

Introduction

Your choice of this product indicates that you are a devotee to excellence in sound reproduction.

We appreciate your patronage and take pride in the long tradition of quality components that our company represents.

So that you can get the most out of your unit, we suggest that you take the time to read through this manual before you hook up and operate your system. This will acquaint you with operating features and system-connection considerations so that your listening pleasure will be enhanced right from the start. You will notice that in all aspects of planning, engineering, styling, operating convenience and adaptability we have sought to anticipate your needs and desires.

Keep this manual handy for future reference.

For your records

Record the serial number, found on the back of the unit, in the spaces designated on the warranty card, and in the space provided below. Refer to the model and serial numbers whenever you call upon your dealer for information or service on this product.

Model _____ Serial Number _____

Unpacking

Unpack the unit carefully and make sure that all accessories are put aside so they will not be lost.

Examine the unit for any possibility of shipping damage. If your unit is damaged or fails to operate, notify your dealer immediately. If your unit was shipped to you directly, notify the shipping company without delay. Only the consignee (the person or company receiving the unit) can file a claim against the carrier for shipping damage.

We recommend that you retain the original carton and packing materials for use should you transport or ship the unit in the future.

The marking of products using lasers (Except for some areas.)



The label is attached to the rear panel and says that the component uses laser beams that have been classified as Class 1. It means that the unit is utilizing laser beams that are of a weaker class. There is no danger of hazardous radiation outside the unit.

WARNING NOTICE:

IN MOST CASES IT IS AN INFRINGEMENT OF COPYRIGHT TO MAKE COPIES OF TAPES OR DISCS WITHOUT THE PERMISSION OF THE COPYRIGHT OWNERS. ANYONE WISHING TO COPY COMMERCIALY AVAILABLE TAPES OR DISCS SHOULD CONTACT THE MECHANICAL COPYRIGHT PROTECTION SOCIETY LIMITED OR THE PERFORMING RIGHTS SOCIETY LIMITED.

For the U.S.A.

Note to CATV system installer:

This reminder is provided to call the CATV system installer's attention to Article 820 - 40 of the NEC that provides guidelines for proper grounding and, in particular, specifies that the cable ground shall be connected to the grounding system of the building, as close to the point of cable entry as practical.

Accessories

- AM loop antenna 1
 - FM indoor antenna 1
 - Loop antenna stand 1
 - Antenna adaptor (75 Ω/300 Ω) 1
 - Batteries (RO3/AAA) 2
 - Remote control unit 1
 - AC plug adaptor 1 (Except for some areas)
 - Speaker cords Red/Black × 2
Blue/Black × 2
Gray/Black × 2
- For the unit with a European AC plug in areas other than Europe.

Contents

Caution: Read the pages marked carefully to ensure safe operation.

Introduction	2	Operation of graphic equalizer	26
Before applying power	3	Operation of CD player	30
Safety precautions	3	Playback operation of cassette decks	35
IMPORTANT SAFEGUARDS	4	DPSS operation	37
Before operation	6	Recording operation on cassette deck (Deck B only)	39
FM DE-EMPHASIS/CHANNEL SPACE switch	7	Recording of CD playback (CCRS)	42
System connections	8	Tape dubbing	48
Controls and indicators	13	Simple Karaoke singing entertainment	49
Operation of remote control unit	16	Presence effect	50
Listening to sound	18	DSP presence	54
Time adjustment	19	Operation with video components	57
Operation of amplifier	20	Operation of timer	58
Reception of radio broadcast	22	In case of difficulty	66
		Specifications	70

⚠ Caution: Read this page carefully to ensure safe operation.

Before applying power

For the U.S.A. and Canada

Important!

Units shipped to the U.S.A. and Canada are designed for operation on 120 volts AC only.

CAUTION: TO PREVENT ELECTRIC SHOCK DO NOT USE THE AC PLUG WITH AN EXTENSION CORD, RECEPTACLE OR OTHER OUTLET UNLESS THE BLADES CAN BE FULLY INSERTED TO PREVENT BLADE EXPOSURE.

For Australia and Europe

Important!

Units shipped to Australia are designed for operation on 240 V AC only.

Units shipped to Europe are designed for operation on 230 V AC only.

For other countries

Important!

Units shipped to countries other than the above countries are equipped with an AC voltage selector switch on the rear panel. Refer to the following paragraph for the proper setting of this switch.

AC voltage selection

This unit operates on 110-120 or 220-240 volts AC. The AC voltage selector switch Type A or Type B on the rear panel is set to the voltage that prevails in the area to which the unit is shipped. Before connecting the power cord to your AC outlet, make sure that the setting position of this switch matches your line voltage. If not, it must be set to your voltage in accordance with the following direction.

Note:

Our warranty does not cover damage caused by excessive line voltage due to improper setting of the AC voltage selector switch.

For the United Kingdom

Important!

Units shipped to the U.K. are designed for operation on 240 volts AC only.

The mains plug must be removed from the wall socket prior to any internal examination.

The wires in this mains lead are coloured in accordance with the following code:

Blue Neutral
Brown Live

The wires in this mains lead must be connected to the terminals in the plug as follows:

Wire colour **Plug terminal marking**
Blue N or Black
Brown L or Red

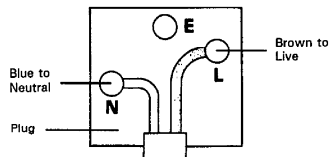

Notes:

1. If a 13-amp plug is used, this must be fitted with a 5-amp fuse.
2. If a 3-pin plug with earthing contact is used, no wire must be connected to the E terminal.

AC voltage selector switch

Type A

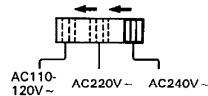



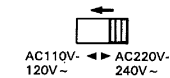

Type B



Move switch lever to match your line voltage with a small screwdriver or other pointed tool.

Safety precautions

WARNING: TO PREVENT FIRE OR ELECTRIC SHOCK, DO NOT EXPOSE THIS APPLIANCE TO RAIN OR MOISTURE.

 <p>CAUTION RISK OF ELECTRIC SHOCK DO NOT OPEN</p> 	<p>CAUTION: TO REDUCE THE RISK OF ELECTRIC SHOCK, DO NOT REMOVE COVER (OR BACK). NO USER-SERVICEABLE PARTS INSIDE, REFER SERVICING TO QUALIFIED SERVICE PERSONNEL.</p>
	<p>THE LIGHTNING FLASH WITH ARROWHEAD SYMBOL, WITHIN AN EQUILATERAL TRIANGLE, IS INTENDED TO ALERT THE USER TO THE PRESENCE OF UNINSULATED "DANGEROUS VOLTAGE" WITHIN THE PRODUCT'S ENCLOSURE THAT MAY BE OF SUFFICIENT MAGNITUDE TO CONSTITUTE A RISK OF ELECTRIC SHOCK TO PERSONS.</p>
	<p>THE EXCLAMATION POINT WITHIN AN EQUILATERAL TRIANGLE IS INTENDED TO ALERT THE USER TO THE PRESENCE OF IMPORTANT OPERATING AND MAINTENANCE (SERVICING) INSTRUCTIONS IN THE LITERATURE ACCOMPANYING THE APPLIANCE.</p>

IMPORTANT SAFEGUARDS

⚠ Caution : Read this page carefully to ensure safe operation.

Please read all of the safety and operating instructions before operating this unit. For best results, follow all warnings placed on the unit and adhere to the operating and use instructions. These safety and operating instructions should be retained for future reference.

1. Power sources — The unit should be connected to a power supply only of the type described in the operating instructions or as marked on the appliance.

2. Power-cord protection — Power-supply cords should be routed so that they are not likely to be walked on or pinched by items placed upon or against them, pay particular attention to cords at plugs, convenience receptacles, and the point where they exit from the unit.

Never pull or stretch the cord.



3. Grounding or polarization — The precautions should be taken so that the grounding or polarization means of this unit is not defeated.

4. Ventilation — The unit should be situated so that its location or position does not interfere with its proper ventilation.

To maintain good ventilation, do not put records or a table-cloth on the unit. Place the unit at least 10 cm away from the walls.

Do not use the unit on a bed, sofa, rug or similar surface that may block the ventilation openings.

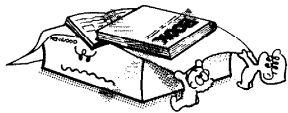

5. Water and moisture — The unit should not be used near water — for example, near a bathtub, washbowl, kitchen sink, laundry tub, in a wet basement, or near a swimming pool, etc.

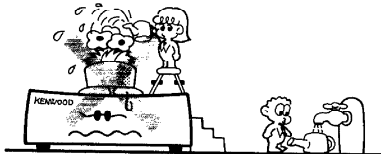

6. Temperature — The unit may not function properly if used at extremely low, or freezing temperatures. The ideal ambient temperature is above +5°C (41°F).

7. Heat — The unit should be situated away from heat sources such as radiators, heat registers, stoves, or other units (including amplifiers) that produce heat.

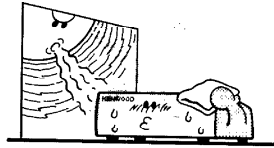

8. Electric shock — Care should be taken so that objects do not fall and liquid is not spilled into the enclosure through openings. If a metal object, such as a hair pin or a needle, comes into contact with the inside of this unit, a dangerous electric shock may result. For families with children, never permit children to put anything, especially metal, inside this unit.

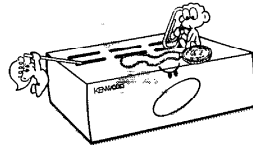

9. Enclosure removal — Never remove the enclosure. If the internal parts are touched accidentally, a serious electric shock might occur.

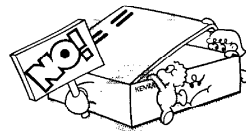

10. Magnetic fields — Keep the unit away from sources of magnetic fields such as TV sets, speaker systems, radios, motorized toys or magnetized objects.

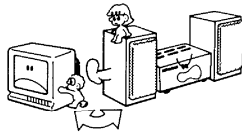

11. Cleaning — Do not use volatile solvents such as alcohol, paint thinner, gasoline, or benzine, etc. to clean the cabinet. Use a clean dry cloth.

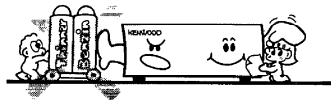

⚠ Caution : Read this page carefully to ensure safe operation.

12. Carts and stands — An appliance and cart combination should be moved with care. Quick stops, excessive force, and uneven surfaces may cause the appliance and cart combination to overturn.



13. Nonuse periods — The power cord of the unit should be unplugged from the outlet when left unused for a long period of time.

14. Abnormal smell — If an abnormal smell or smoke is detected, immediately turn the power OFF and pull out the power cord. Contact your dealer or nearest service center.

POWER OFF!



15. Damage requiring service — The unit should be serviced by qualified service personnel when:

- A.** The power-supply cord or the plug has been damaged; or
- B.** Objects have fallen, or liquid has been spilled into the unit; or
- C.** The unit has been exposed to rain; or
- D.** The unit does not appear to operate normally or exhibits a marked change in performance; or
- E.** The unit has been dropped, or the enclosure damaged.

16. Servicing — The user should not attempt to service the unit beyond that described in the operating instructions. All other servicing should be referred to qualified service personnel.

17. Outdoor antenna grounding — If an outside antenna is connected to the receiver, be sure the antenna system is grounded so as to provide some protection against voltage surges and built up static charges. Section 810 of the National Electrical Code, ANSI/NFPA 70, provides information with respect to proper grounding of the mast and supporting structure, grounding of the lead-in wire to an antenna discharge unit, size of grounding con-

ductors, location of antenna discharge unit, connection to grounding electrodes, and requirements for the grounding electrode. See Figure.

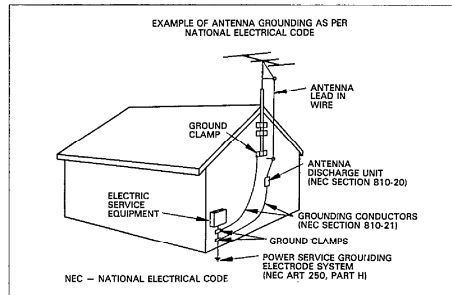

18. Power lines — An outdoor antenna should be located away from power lines.

19. AC outlets — Do not connect other audio equipment with a power consumption larger than that specified to the AC outlet on the rear panel. Never connect other electrical units, such as an iron or toaster, to it to prevent fire or electric shock.

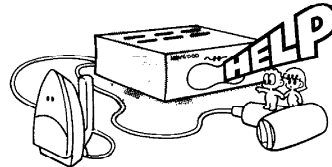

For the U.S.A.

CAUTION:

Use of controls or adjustments or performance of procedures other than those specified herein may result in hazardous radiation exposure.

In compliance with Federal Regulations, following are reproductions of labels on, or inside the product relating to laser product safety.

KENWOOD CORPORATION
SHIONOGI SHIBUYA BUILDING 17-5,
2-CHOME, SHIBUYA, SHIBUYA-KU,
TOKYO, JAPAN

KENWOOD CORP. CERTIFIES THIS EQUIPMENT
CONFORMS TO DHHS REGULATIONS NO. 21 CFR
1040.10, CHAPTER I, SUBCHAPTER J.

Location: Back Panel

Notes:

- 1. Item 3 is not required except for grounded or polarized equipment.
- 2. Item 17 and 18 are not required except for units provided with antenna terminals.
- 3. Item 17 complies with UL in the U.S.A.

Before operation

■ Notes on cassette tape

● Safety tab (accidental erasure prevention tab):

After an important recording has been finished, break the safety tab, to prevent the recorded contents from being erased or recorded on accidentally.

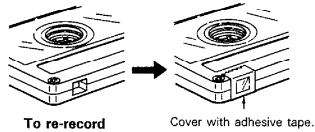
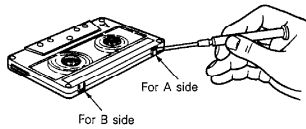

● To store cassette tapes:

Do not store the tapes in a place which is subject to direct sunlight, or near equipment that generates heat. Keep the cassette tapes away from any magnetic field.

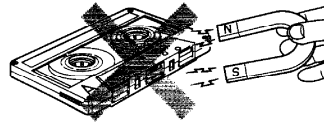

● When there is slack in the tape:

In such a case, insert a pencil into the reel hole and wind the reel hub to remove the slack.

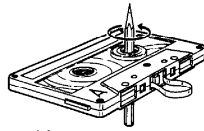

Notes:

1. 120-minute cassette tape:

Since a 120-minute cassette tape is very thin, the tape could adhere to the pinch roller or be easily cut. It is recommended that these tapes not be used with this unit to prevent possible damage.

2. Endless tapes:

Do not use an endless tape, as this could damage the mechanism of the unit.

■ Cleaning the head section

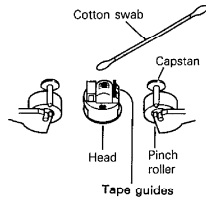

Cleaning the heads and peripheral components:

For maintaining the best condition of the deck and for longer service life, always keep the head (recording/playback/erase), capstan and pinch roller clean.

To clean them, perform the following:

1. Open the cassette holder.
2. Using a cotton swab dipped in alcohol, clean the head (recording/playback/erase), capstan and pinch roller carefully.

Demagnetizing the head

When the recording/playback head is magnetized, the sound quality will be deteriorated. In such a case, demagnetize the head using a commercially available demagnetizer (head eraser).

Note:

There are precisely aligned parts around the heads, including the tape guides. When cleaning, pay special attention so as not to apply shock to them.

■ Beware of condensation

When water vapor comes into contact with the surface of cold material, water drops are produced.

If condensation occurs, correct operation may not be possible, or the unit may not function correctly.

This is not a malfunction, however, and the unit should be dried. (To do this, turn the POWER switch ON and leave the unit as it is for several hours.)

Be especially careful in the following conditions:

- When the unit is brought from a cold place to a warm place, and there is a large temperature difference.
- When a heater starts operating.
- When the unit is brought from an air-conditioned place to a place of high temperature with high humidity.
- When there is a large difference between the internal temperature of the unit and the ambient temperature, or in conditions where condensation occurs easily.

■ Disc handling precautions

Handling
Hold compact discs so that you do not touch the playing surface.

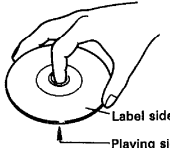

Do not attach paper or tape to either the playing side or the label side of compact discs.

Caution on disc used

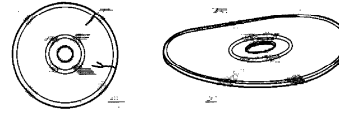

Cleaning
If fingerprints or foreign matter become attached to the disc, lightly wipe the disc with a soft cotton cloth (or similar) from the center of the disc outwards in a radial manner.

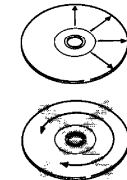

Storage
When a disc is not to be played for a long period of time, remove it from the CD player and store it in its case.

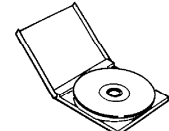

Never play a cracked or warped disc.
During playback, the disc rotates at high speed in the player. Therefore, to avoid danger, never use a cracked or deformed disc or a disc repaired with tape or adhesive agent.

FM DE-EMPHASIS/CHANNEL SPACE switch (Except for some areas)

The FM DE-EMPHASIS/CHANNEL SPACE switch on the rear panel is set to the correct setting that prevails in the area to which the unit is shipped. However, if the FM DE-EMPHASIS/CHANNEL SPACE setting is not matched to the area where the unit is to be used; for instance, when you move from area 1 to area 2 or vice versa, desired reception of AM/FM broadcasts is not expected. In this case, change the FM DE-EMPHASIS/CHANNEL SPACE setting in accordance with the area corresponding to the table. The FM DE-EMPHASIS is switched over at the same time.

- When changing the setting of the FM DE-EMPHASIS/CHANNEL SPACE switch, first disconnect the power cord, then reset the channel space switch, connect the power cord again, and turn the power on.

Area	CHANNEL SPACE freq.	FM DE-EMPHASIS
1. U.S.A., Canada, and South American countries	FM: 100 kHz AM: 10 kHz	75 μ s
2. Other countries	FM: 50 kHz AM: 9 kHz	50 μ s

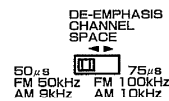

Memory backup function

Stored contents cleared at least 3 days after the last power OFF (STAND BY mode)	Cassette deck (Direction and recording level)
Stored contents cleared immediately when power plug is unplugged from power outlet	Clock display of preamplifier/tuner
Stored contents cleared in at least 3 days after power plug is unplugged from power outlet	Preset stations of preamplifier/tuner

Dolby noise reduction manufactured under license from Dolby Laboratories Licensing Corporation. "DOLBY" and the double-D symbol  are trademarks of Dolby Laboratories Licensing Corporation.

Manufactured under license from Dolby Laboratories Licensing Corporation. Additionally licensed under one or more of the following patents: U.S. numbers 3,632,886, 3,746,792 and 3,959,590; Canadian numbers 1,004,603 and 1,037,877. "Dolby" and the double-D symbol  are trademarks of Dolby Laboratories Licensing Corporation.

System connections

Make connection as shown below. When connecting the related system components, refer also to the instruction manuals of the related components.
 When connecting the parallel cord, be sure to match the colors of the sockets.
 Do not plug in the power lead until all connections are completed.
 For details on antenna and speaker connections, see pages 9, 10 and 11, respectively.

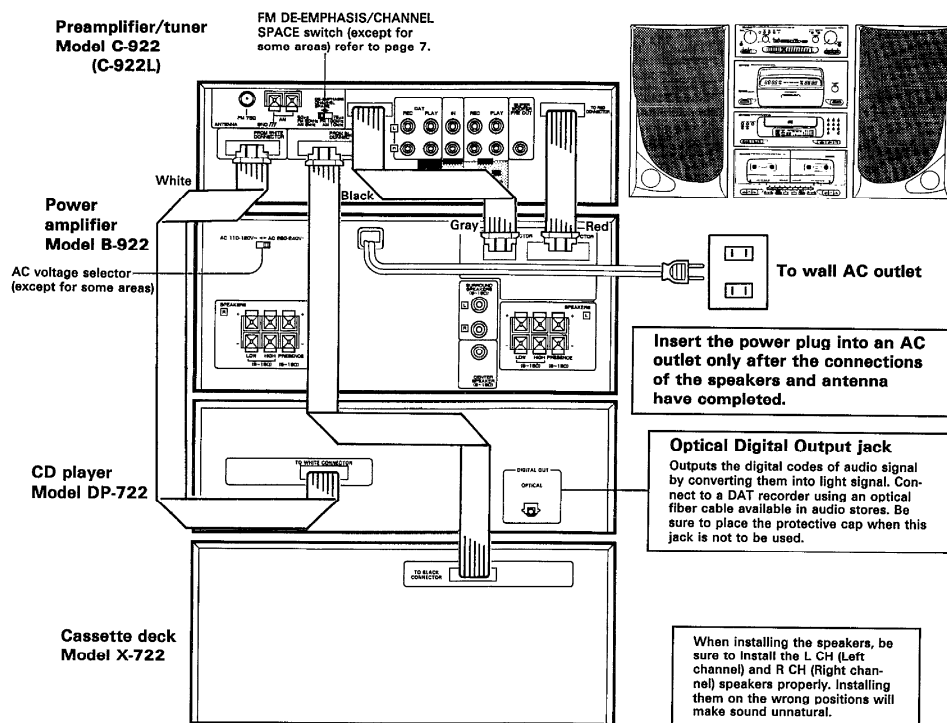

■ Connection of parallel cord

- Hold the connector of the parallel cord in parallel with the socket on the rear panel, and insert securely until it clicks.
- Connect the parallel cord by matching the colors of the connector and socket.
- When unplugging the parallel cord, push and hold the two ends of the connector and pull the connector straight from the rear panel socket.

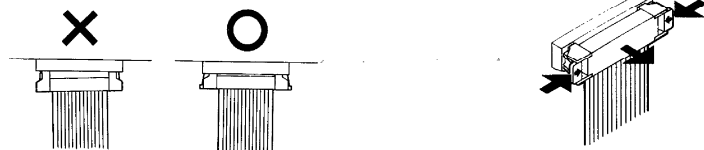

Notes:

1. Connect all cords firmly. If connections are loose, there could be loss of sound or noise produced.
2. When plugging and unplugging connection cords, be sure to first remove the power cord from the AC outlet. Plugging/unplugging cords without removal of the power cord can cause malfunctions or damage to the unit.

Connection method to each antenna terminal

- ① Push lever down. ② Insert conductor. ③ Return lever up.

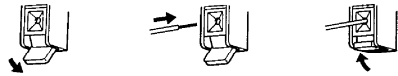

■ AM loop antenna connection

The supplied antenna is for indoor use. Place it as far as possible from the main system, TV set, speaker cords and power cord, and set it to a direction which provides the best reception.

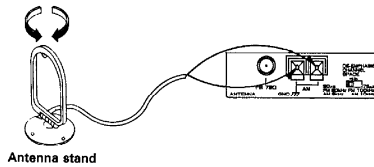

■ AM outdoor antenna connection

If the reception is poor when the AM loop antenna is used, distribute a vinyl-coated wire of more than 6 meters outdoors, without disconnecting the loop antenna.

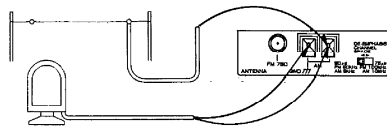

■ FM indoor antenna connection

<p>①</p> <p>1. To loosen screw</p> <p>Supplied FM indoor antenna</p> <p>2. Insert antenna cable.</p> <p>3. To tighten screw</p> <p>Antenna adaptor</p>	<p>②</p> <p>Plug securely into FM ANTENNA terminal.</p>	<p>③</p> <p>1. Find the position that provides best reception.</p> <p>2. Fix two ends.</p> <p>Set to receiving mode.</p> <p>Unit</p>
--	---	--

■ FM outdoor antenna connection

It is recommended to install an exclusive FM outdoor antenna to capture FM broadcasts with high sound quality. Use a coaxial cable for the connection between the outdoor antenna and FM ANTENNA terminal on the rear panel. For the connection between the coaxial cable and FM ANTENNA terminal, please refer to the illustration.

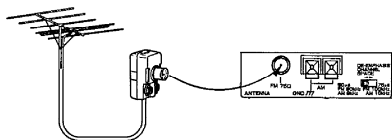

■ 75 Ω coaxial cable connection (Except for some areas)

① Arrange the coaxial cable as illustrated.

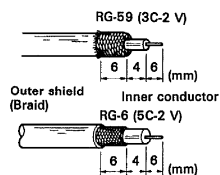

② Open the 75 Ω/300 Ω antenna adaptor. Press the claws in the direction of the arrows to release the lock and pull out the cover.



③ Detach the ring from the antenna adaptor. Then put the ring on the pole in the cover.

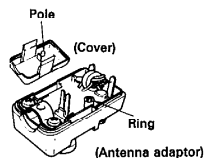

④ Remove the band and insert the inner conductor to the slit.

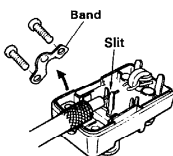

⑤ Fasten the band with screws, using the screwdriver. Close the cover.

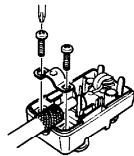

⑥ Connect the adaptor to the antenna terminal.

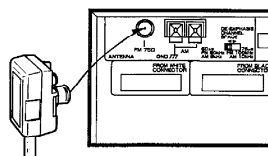

Note:
To connect the 300 Ω feeder, attach the ring shown in the figure. If the ring is not attached, the sensitivity decreases.

■ Connection of front speakers

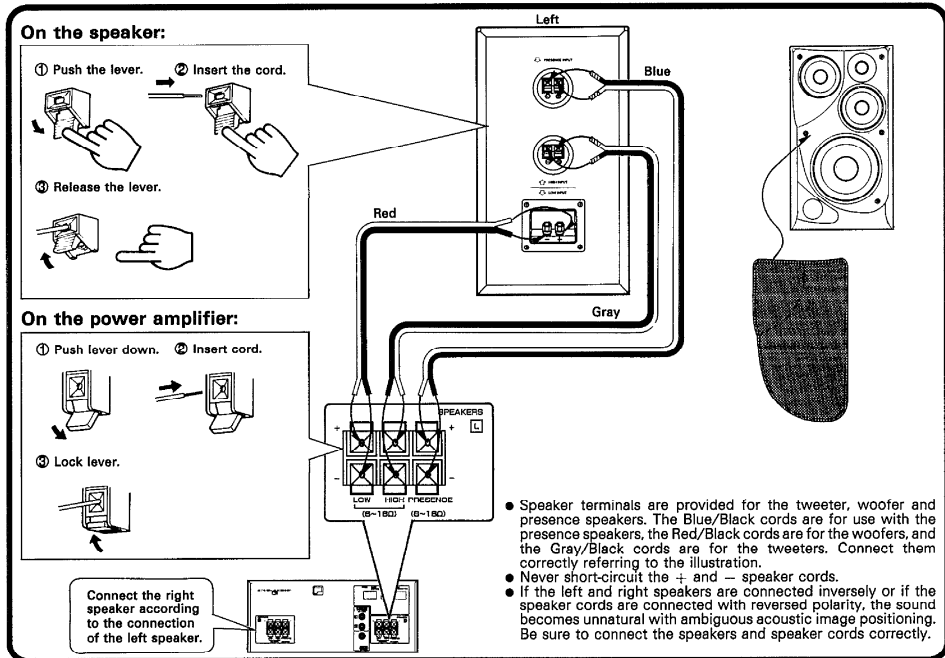

■ Connection of surround rear and center speakers

The center speaker should be connected for Dolby Surround, 3-Stereo or DSP S.4CH.

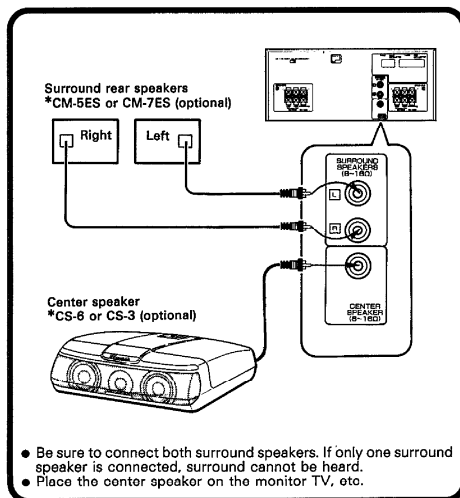

*IMPORTANT

This option may not be available in some areas. For details on options, consult your dealer.

■ Connection of super woofer

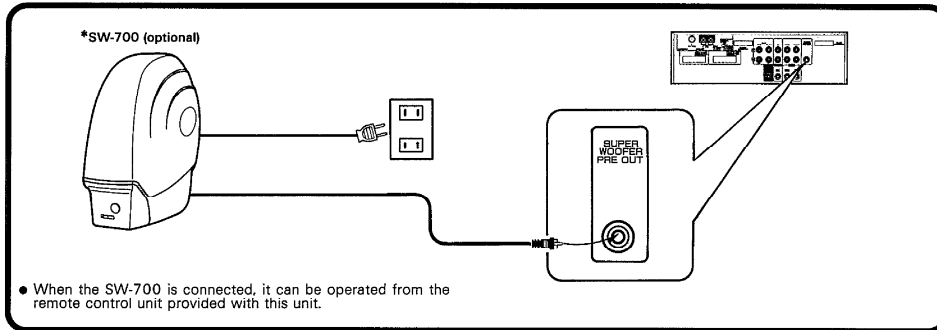

■ Connection of Audio/Visual components (optional)

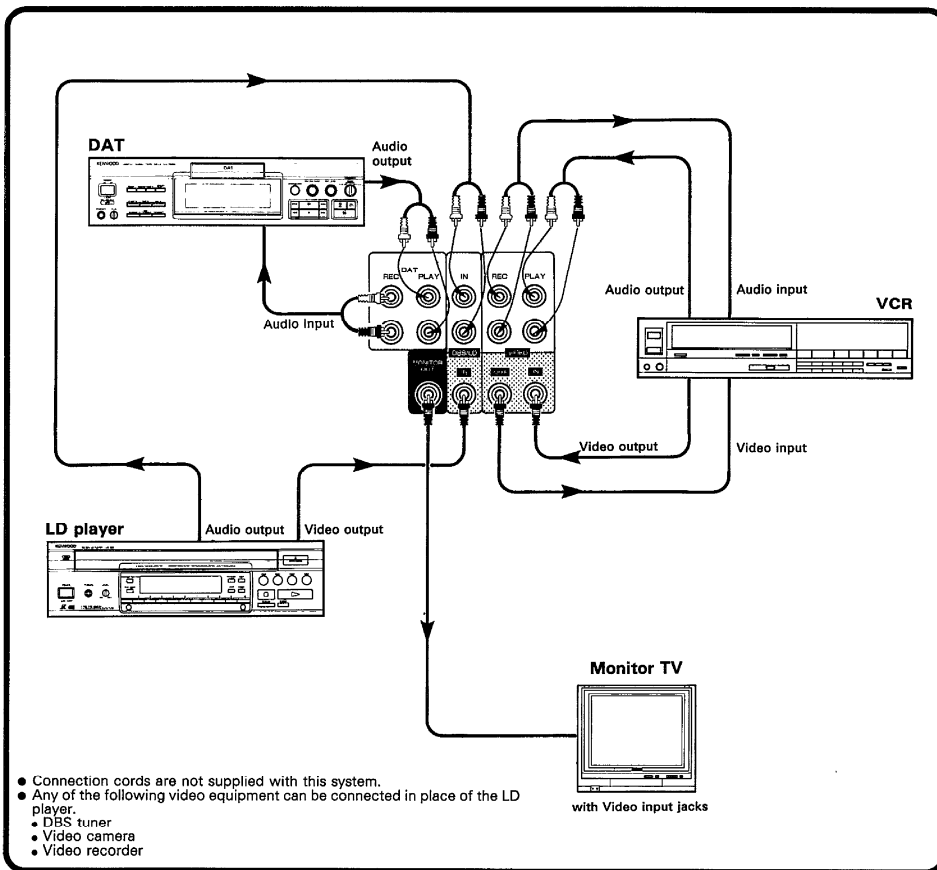

Controls and indicators

■ Preamplifier/tuner unit

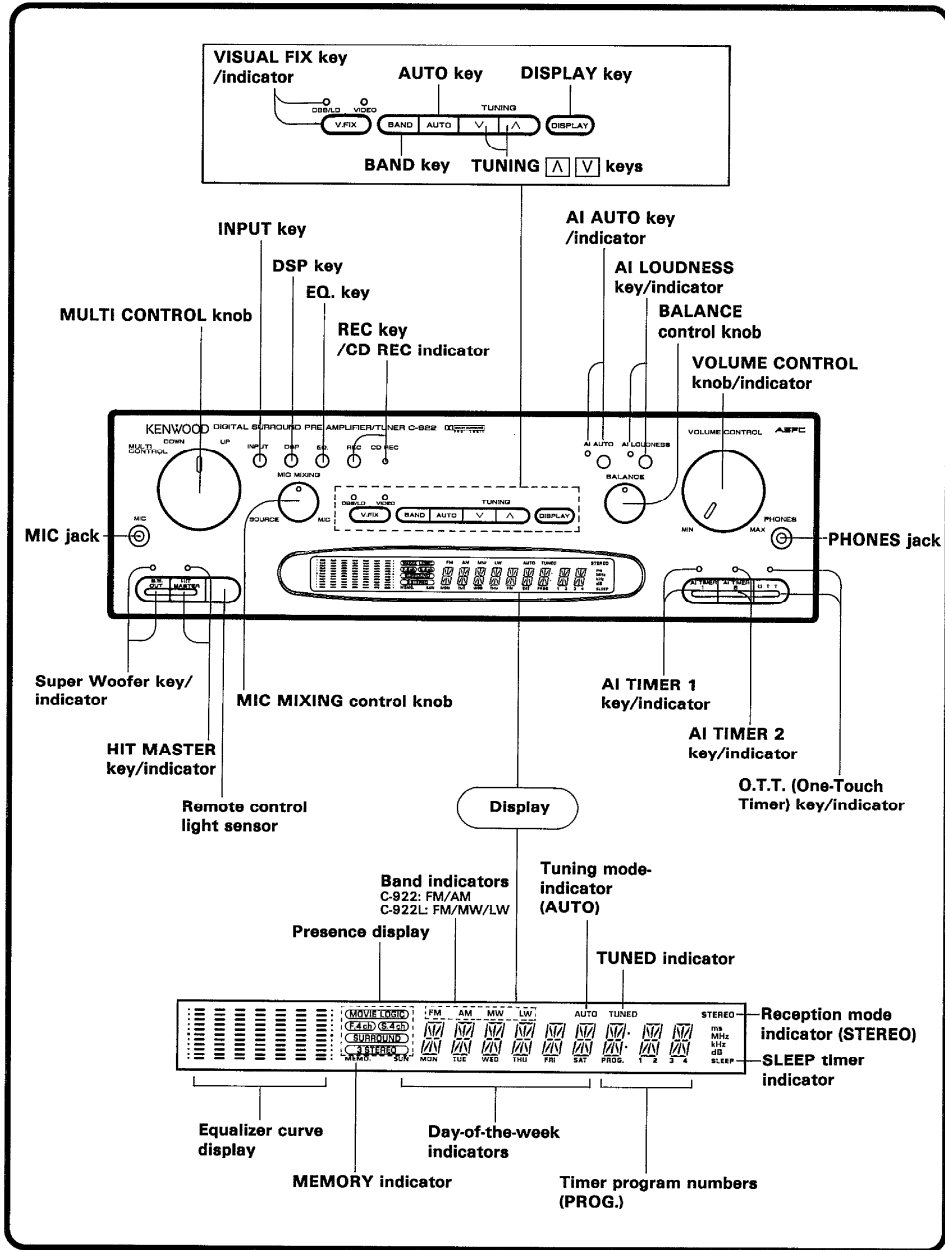

■ CD player

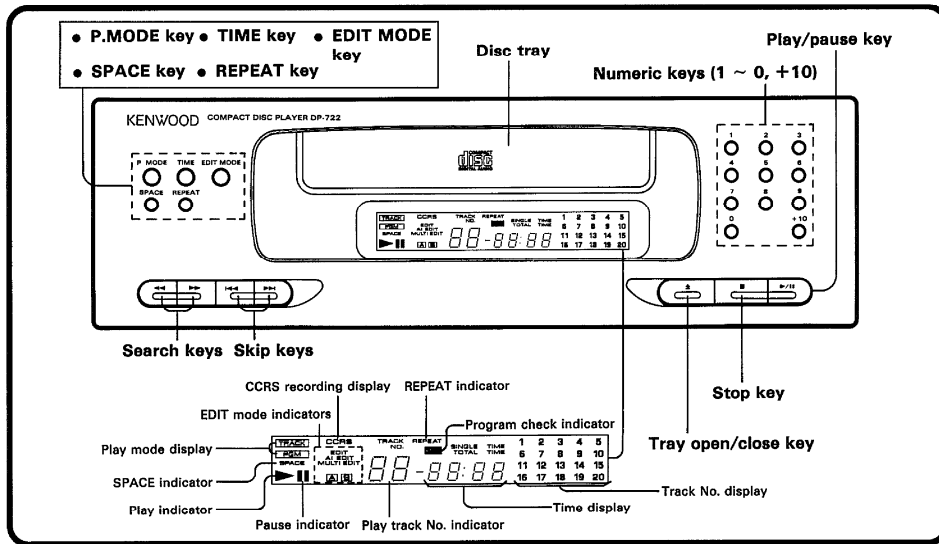

■ Cassette deck

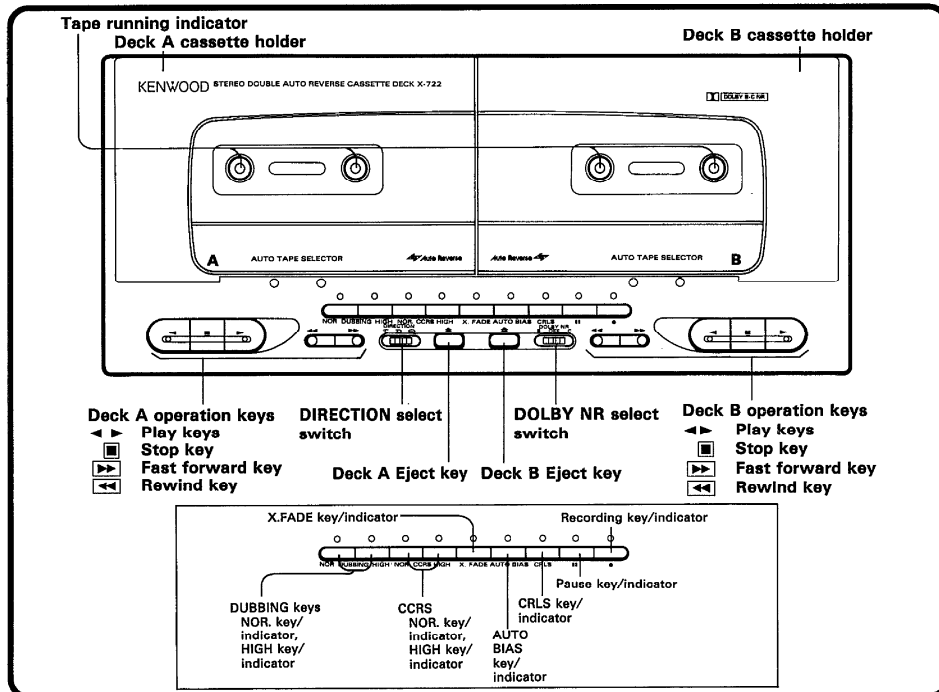

■ Power amplifier unit

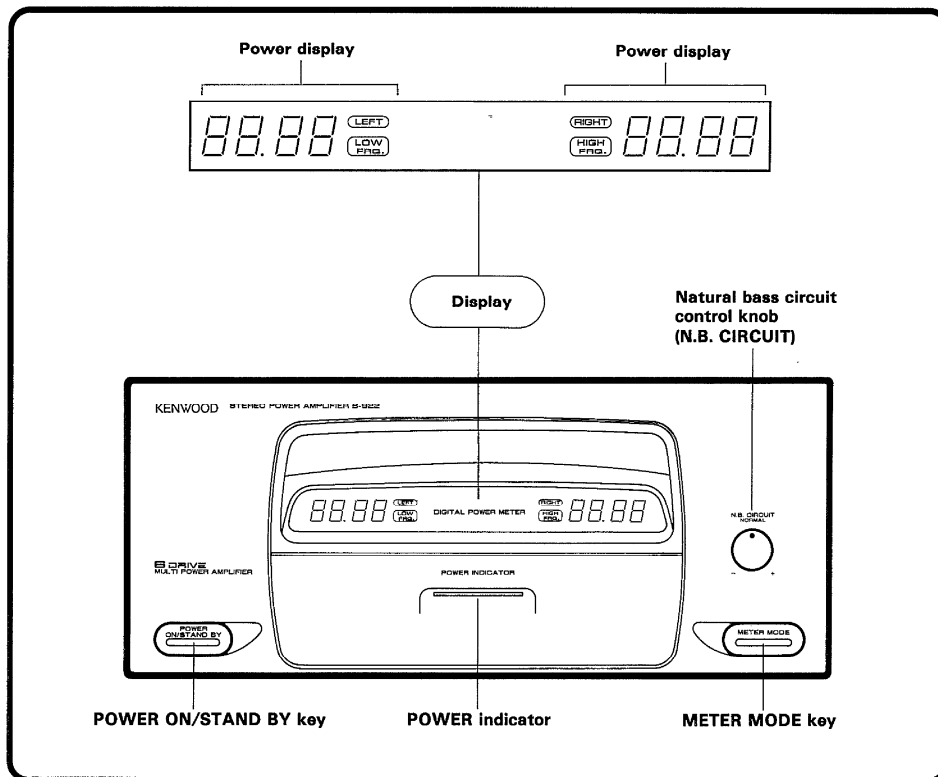

■ Speaker

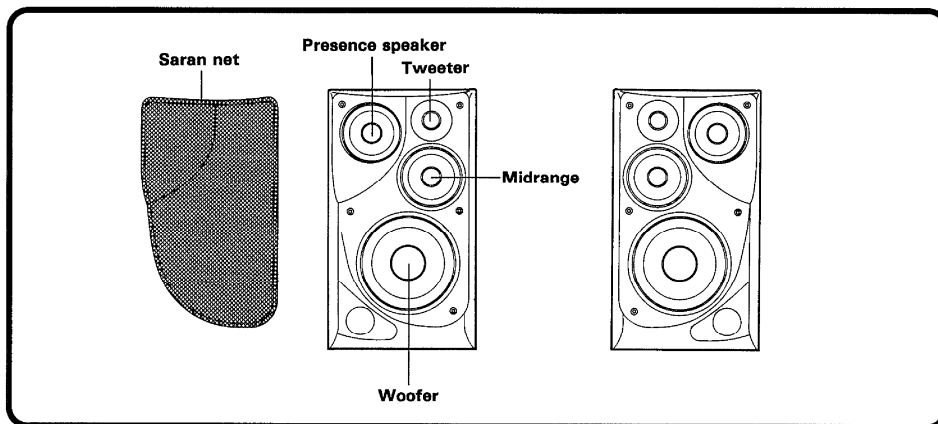

Operation of remote control unit

■ Loading batteries

1 Remove the cover.

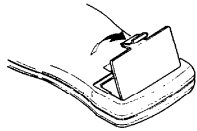

2 Insert batteries.

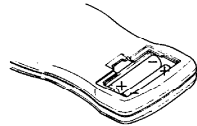

- Insert two AAA-size (R03) batteries as indicated by the polarity marking.

3 Close the cover.

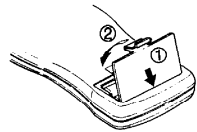

■ Operation procedure

Plug the power cord of the system into an AC wall outlet, and press the **POWER** key on the remote control unit to turn the power on. When the power is turned on, press the key of the source component to be operated.

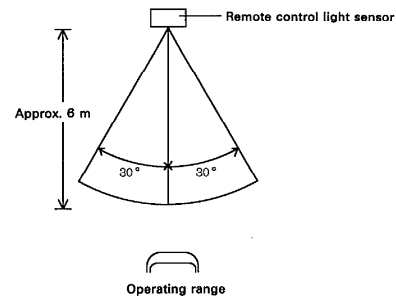

- When two operation keys on the remote control unit are pressed successively, press each key securely reserving an interval of more than 1 second for each press.

Notes:

1. The supplied batteries are intended for use in operation checks. Therefore, their lives may be shorter than ordinary batteries.
2. When the remote-controllable distance gets shorter than before, replace both batteries with new ones.
3. Malfunction may occur if direct sunlight or the light of a high-frequency lighting fluorescent lamp enters the remote control light sensor. In such a case, change the system installation position to prevent the malfunction.

SUPER WOOFER operation key
Set the A/B switch to "A" to operate the super woofer

POWER key

Numeric keys/day-of-the-week keys
Can be used as the numeric keys for the CD player when the CD input is selected.
Can be used as the numeric keys of the TUNER when the TUNER input is selected.

Equalizer operation keys
AI AUTO key, AI LOUDNESS key
M.CALL key: Memory call key. Press repeatedly to recall preset equalizer curves.

TAPE deck A/B operation keys
Set the A/B switch to "A" when operating deck A. (The keys are invalid.)
Set the A/B switch to "B" when operating deck B.

Input select keys

DISPLAY key
Each press of this key switches the display between the preamplifier and tuner display.

METER MODE key
Every time this key is pressed, the display of the power amplifier changes.

HIT MASTER key

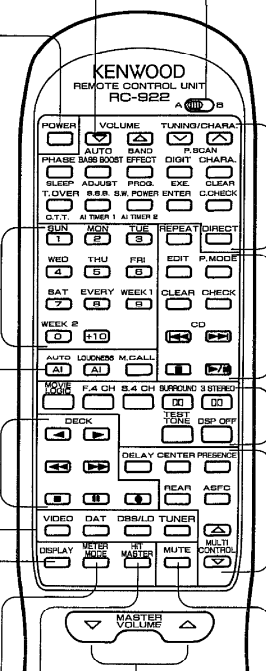

Remote control function A/B switch
switch
Some remote control keys have two functions, which can be switched over according to purposes
Keys marked with white characters alone can be used regardless of the A and B settings.
Some keys are marked with white and gold characters. When this switch is set to A, the keys function as described with white characters. In the B setting, the keys function as described with gold characters.

TUNER operation keys
When A/B switch is set to A:
TUNING/CHARA. keys, DIGIT key
CHARA. key, ENTER key, DIRECT key
When A/B switch is set to B: AUTO key, BAND key, P.SCAN keys

Clock/timer operation keys
When A/B switch is set to B: SLEEP key, ADJUST key, PROG. key
EXE. key, CLEAR key, C.CHECK key
O.T.T. key, AI TIMER 1 key, AI TIMER 2 key

CD player operation keys
REPEAT key, EDIT key, P.MODE key
CLEAR key, CHECK key, key, key
 key, key

DSP presence keys
MOVIE LOGIC key, F.4CH key, S.4CH key
 SURROUND key, 3 STEREO key
DSP OFF key, TEST TONE key

Presence control keys
DELAY key, CENTER key, PRESENCE key, REAR key, A.S.F.C. key, MULTI CONTROL keys (,)

MUTE key
Reduces the volume temporarily. The indicator on the VOLUME CONTROL knob blinks while muting is active.

MASTER VOLUME control keys
Adjusts the volume. While these keys are operated, the VOLUME CONTROL knob on the main unit rotates and the indicator on it blinks at high speed.

Model Name: RC-922
Infrared ray system





Listening to sound

For details, also refer to corresponding pages for each player operations.

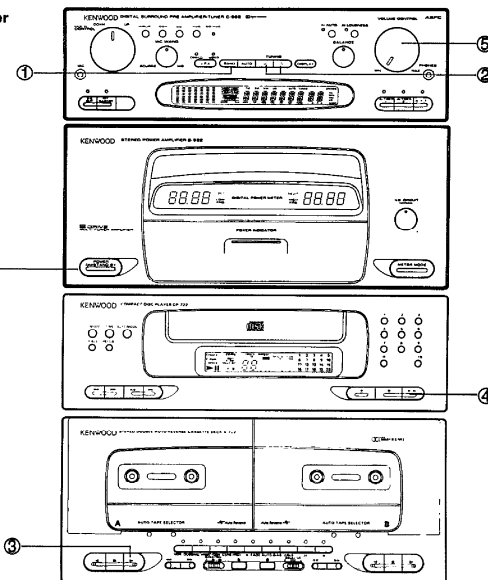
For the adjustment of the time displayed on the preamplifier/tuner, please read the next page.

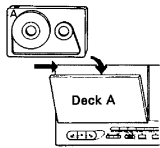
Press the **POWER** key of the power amplifier.

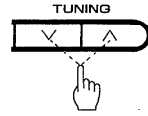
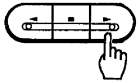
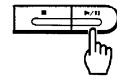

	To listen to a radio broadcast	To listen to a tape	To listen to a CD
1	<p>Select the tuner input. Select a broadcasting band by pressing the BAND key ①.</p> 	<p>Insert a tape in Deck A.</p> 	<p>Place a CD on the tray.</p> 
2	<p>Select a station. Press the TUNING/CHARA. key ②.</p> 	<p>Play the tape. Press the play key ③.</p> 	<p>Play the CD. Press the play/pause key ④.</p> 
3	<p>Adjust the volume.</p>  <p>● Turn the VOLUME CONTROL ⑤ for an optimum volume.</p>		

Note:
If sound is not output, check the connections described from page 8 again.

Time adjustment

The preamplifier/tuner unit is provided with a clock function. Adjust the clock to the exact time, especially when the timer function is to be used.

The clock function incorporates the calendar check function which helps identify the day of the week of a date entered in year, month and day (refer to page 65).

Remote control only

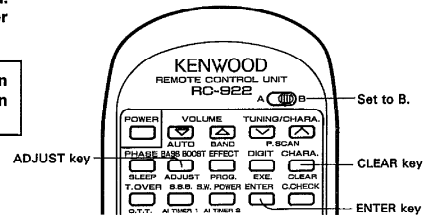

1 Press the ADJUST key.



INPUT YEAR
YEAR 1991

2 Input the year using the numeric keys, and press the ENTER key.

To input 1992: press **1**, **9**, **9**, **2**.

- If you commit a mistake in the input of numeric keys, press the **[CLEAR]** key, and re-start the input from the beginning.



YEAR 1992
INPUT DATE

3 Input the month then the day, and press the ENTER key.

To input March 7: press **0**, **3**, **0**, **7**.

To input December 30: press **1**, **2**, **3**, **0**.

- If you commit a mistake in the input of numeric keys, press the **[CLEAR]** key, and re-start the input from the beginning.



DATE 0101
DATE 1230
INPUT TIME

4 Input the time of the day.

To input 9:05AM: press **0**, **9**, **0**, **5**.

To input 4:50PM: press **1**, **4**, **5**, **0**.

- If you commit a mistake in the input of numeric keys, press the **[CLEAR]** key, and re-start the input from the beginning.

Use the 24-hours system.

TIME 0000
TIME 1650

5 Press the ENTER key.



- For correct time adjustment, it is recommended to press the **[ENTER]** key at the same time as a time announcement.

TIME 1650
END

Clock starts to work.

Note:
The time display blinks after a power failure or when the power cord was unplugged from the power outlet. In this case, adjust the time again.

Displayed contents and DISPLAY key

Every time the **[DISPLAY]** key is pressed while a radio station is received, the displayed content is switched to the frequency to the station name, presence display, present time, and date (month and day). When a key associated with tuning is pressed while the date or time is being displayed, it is switched to the frequency display, and returns to the previous content in a few seconds. When the **[DISPLAY]** key is pressed while the power is OFF, the displayed content is switched alternately between the date and time.

Operation of amplifier

Press the POWER key on the power amplifier.

- The **POWER** key of the power amplifier can turn the power of the whole of the basic system ON/OFF.

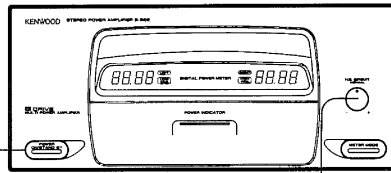
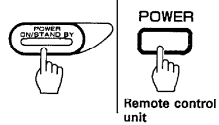

N.B. CIRCUIT control knob

Adjusting the volume

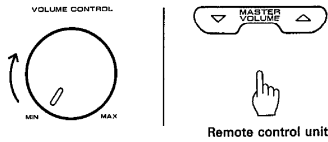

Remote control unit

- When the volume is adjusted from the remote control unit, the point indicator on the VOLUME CONTROL knob blinks and rotates together with the control knob.

To mute sound temporarily **Remote control only**



- The VOLUME CONTROL indicator blinks. Pressing the key again resumes the previous volume.

Adjusting the left and right volume balance

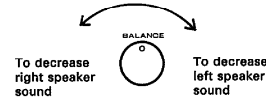

- Set to center position in the presence mode.

Compensation of bass sound



Power amplifier

N.B. CIRCUIT: Natural Bass Circuit

- Usually set the knob to the NORMAL position.
- Adjust to obtain a more natural bass sound.

Selecting the input sources

① Set to the input mode.

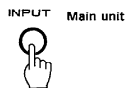

Proceed to step ② below while the display is showing the input display (about 5 seconds).

② Select the source to be played.

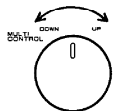

The sources are switched over in the sequence as shown below.
TUNER ↔ TAPE ↔ DAT
(Frequency display)

CD ↔ DBS/LD ↔ VIDEO

Remote control unit

VIDEO DAT DBS/LD TUNER



The CD player and TAPE deck sources can be selected by pressing any of the related operation keys.

STAND BY mode of POWER key

When the power cord of this system is plugged into an AC power outlet, the display lights up regardless of the ON/OFF setting of the **POWER** key. (The "clock" display appears on the preamplifier/tuner, and the "OFF" display appears on the power amplifier.)

This indicates that a small amount of current is being supplied to the unit to back up the memory contents and support the timer function. This mode is referred to as the Stand By mode. While the display is lit, the power of the system can be switched ON/OFF from the remote control unit.

Input selection and "easy operation" feature

Selecting the input source (TAPE, TUNER, CD) will automatically set the selected program source to play mode (only TUNER with remote control). When a program source is set to play mode, that input source automatically be selected.

The input source selected at the moment the power is switched ON is the last source (TUNER, CD, etc.) selected before switching the power OFF.

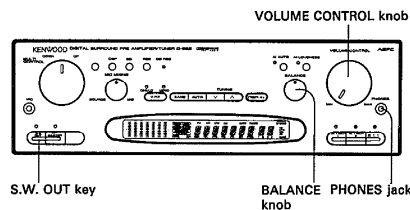

■ Listening through headphones

1 Insert the headphone plug into the headphones jack.

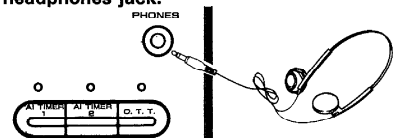

- Sound from all speakers is turned off.
- The sound through headphones is not affected with N.B. CIRCUIT.

2 Adjust the volume.

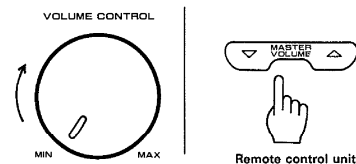

- Be sure to minimize the volume before unplugging the headphone plug.

■ Listening to enhanced bass

By connecting an optional super woofer, the bass of the sound can be enhanced providing a more realistic feeling.

The connection of super woofer, described on page 12, must be completed before proceeding to the following.

1 Press the S.W. OUT key.

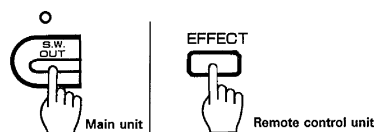

2 Adjust the super woofer volume.

Adjust the VOLUME control on the remote control unit or the super woofer.

- Once the super woofer volume is set, it is varied with the same balance with respect to the master volume by varying the VOLUME CONTROL.

METER MODE of the power amplifier

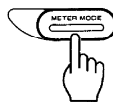

The power amplifier of the system incorporates six amplifiers for the treble, bass and presence effect. The current power output can be converted into a digital value and displayed. Each press of the [METER MODE] key switches the display content as shown below.

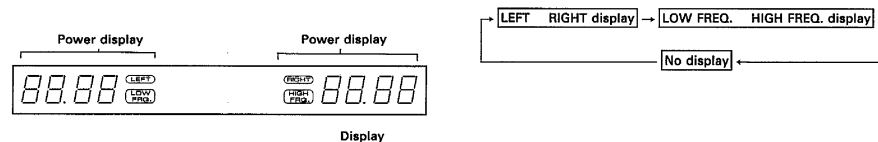

Connection of microphone

Please refer to "Simple Karaoke singing entertainment" on page 49.

Reception of radio broadcast

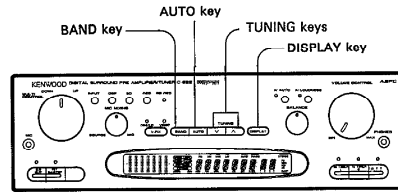

■ Receiving broadcast stations and storing them in memory (preset operation)

1 Select the broadcast band.

- The frequency is displayed for a few seconds when a key associated with tuning is pressed.



The bands are switched as follows every time the **[BAND]** key is pressed.

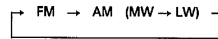

2 Display the frequency display.

- Every time the **[DISPLAY]** key is pressed, the displayed contents are switched in order of Frequency → Broadcast station name → Presence display → Present time → Date (month & day).



Frequency display

3 Select the tuning mode.

- Normally, select the auto mode (with **AUTO** lighted).

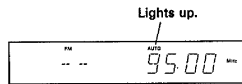

Lights up.

Press the key to select the auto (**AUTO** lighted) or manual (not lighted) mode.

4 Tune the desired station.

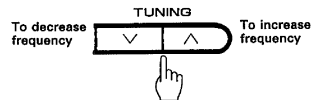

Auto tuning mode	Manual tuning mode
Press once. (Tuning stops automatically when a station is received.)	Press repeatedly, or press and hold, until the desired station is received.

- The **[TUNED]** indicator lights up when a station is received.
- Use manual tuning mode when the radio wave is weak and noisy.
At this time, the stereo FM broadcast is received in monaural mode.

5 Store the station in preset memory. **Remote control only**

- ① Press the **[ENTER]** key.



[MEMO.] lights up for approx. 5 sec.

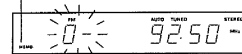

- Up to 20 broadcast stations can be preset regardless of the broadcasting bands.
- Proceed to step ② before **[MEMO.]** stops lighting.

- ② Press the desired numeric key.



[MEMO.] goes off.

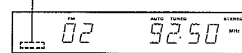

Examples of input

To select preset No. 5: **[5]**

To select preset No. 15: **[+10][5]**

To select preset No. 20: **[+10][+10][0]**

- When a station has previously been preset under the numeric key pressed, the newly preset station replaces the previous station.

Preparation:
Set the A/B switch on the remote control unit to "B".

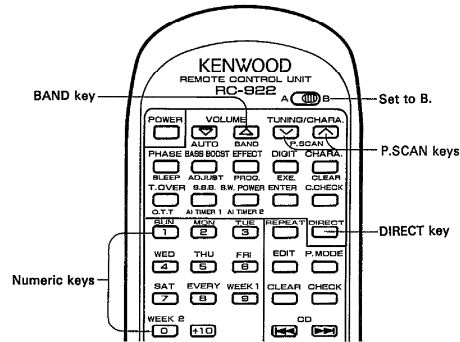

■ Receiving a preset station

Remote control only

Select the desired station.

Press the numeric key under which the station is preset.



- The frequency of the station received will be displayed.

■ Listening to all preset stations in sequence (PRESET SCAN)

Remote control only

Press the P.SCAN key.

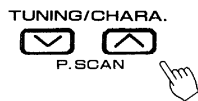

- Every time [UP] is pressed, the preset stations are received in order of 1 → 2 19 → 20 → 1
- Every time [DOWN] is pressed, the preset stations are received in order of 20 → 19 2 → 1 → 20
- When a key is held depressed, the preset stations are received in sequence at 0.5-second intervals. The station being received when the key is released will continue to be received.

■ Direct tuning of radio stations

If you know the frequency of the desired station, it can be received directly by inputting the frequency using the numeric keys.

Remote control only

1 Select the broadcast band.

- One of FM or AM (MW/LW).



2 Press the DIRECT key.



3 Input the frequency of the desired station by pressing the numeric keys.

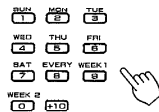

Example of input

Desired station	Order of pressing numeric keys
FM 90 MHz	9 . 0 . 0 (100 kHz space)
	9 . 0 . 0 . 0 (50 kHz space)
FM 102.5 MHz	1 . 0 . 2 . 5 (100 kHz space)
	1 . 0 . 2 . 5 . 0 (50 kHz space)
AM (MW) 810 kHz	8 . 1 . 0
AM (MW) 1260 kHz	1 . 2 . 6 . 0

- If you commit a mistake in the input of numeric keys, press the [CLEAR] key, and re-start the input from the beginning.

■ Displaying station names Remote control only

Station names composed of up to four digits of characters and/or symbols can be displayed on the preamplifier/tuner receiver display.

Example: To receive FM 93.4 MHz, input its name with characters "CBE", and preset them under numeric key 3.

1 Receive FM 93.4 MHz, and enter the character input mode.

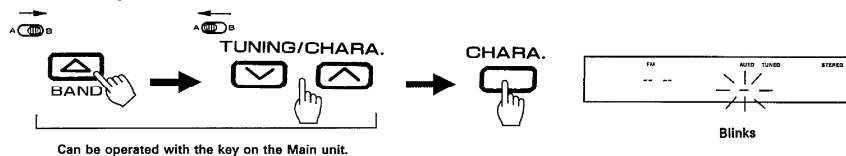

2 Select the characters to be displayed with that station.

① Display the desired character.

TUNING/CHARA.

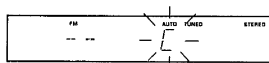
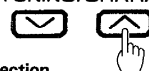

② Establish the selection.

DIGIT

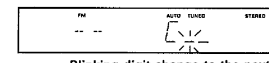

Blinking digit change to the next digit.

③ Repeat steps ① and ② until all of the required characters have been input.

- To select "C", press the UP segment three times.
- To insert a space, simply press the DIGIT key.

Types of characters that can be input

After having pressed the CHARA. key, press the TUNING/CHARA. key to display the characters available.

ABCD...XYZ012...9

Blank position

3 End the character input.

The character input also terminates automatically when fourth character has been input.



Press the CHARA. key to terminate character input with three characters or less.

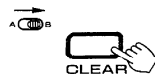

In case you commit an input mistake, press the CLEAR key and re-start from the first digit.

4 Preset them under key 3.

① Press the ENTER key.

ENTER



MEMO. light up.

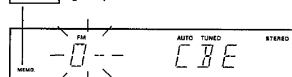

② Press numeric key 3.

TUE



Press while MEMO. is lighted.



Example: When a station name is displayed with the DISPLAY key.

(End of preset)

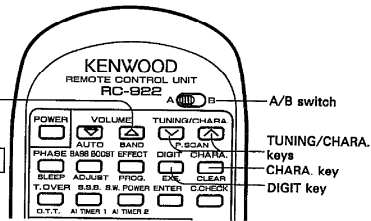

■ Changing a station name Remote control only

Example: To change station name "FHNB" preset with AM (MW) 810 kHz frequency under key **2** numeric keys to "FEN".

1 Receive preset station of **2** by preset tuning, and enter the character input stand-by mode.

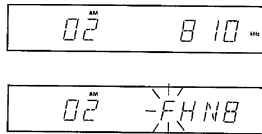

2 Move the blinking digit to the second digit.



Blinking digit change to the next digit.

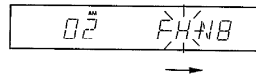

3 Select "E" with the TUNING/CHARA. key.

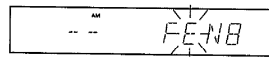

4 Move the blinking digit by two digits.



Press twice.

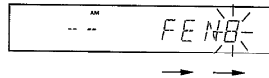

5 Select the blank with the TUNING/CHARA. key.

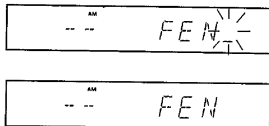

• The character input terminates automatically when fourth character has been input.

6 Preset the new name under numeric key **2**.

① Press the **ENTER** key.

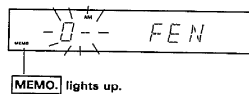

MEMO lights up.

② Press numeric key **2**.

Press while MEMO is lighted.

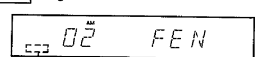

MEMO goes off.

Example: When a station name is displayed with the **DISPLAY** key.

(End of change)

Operation of graphic equalizer

This unit provides seven factory-preset equalizer curves to allow compensation for the reproduce sound. In addition it also provides the AI (Artificial Intelligence) function as described below to allow listening to different music sources with optimum tones.

1. AI AUTO (available only for CD play)

Checks and analyzes automatically the frequency components contained in a disc, and plays the disc with the optimum equalizer curve for it.

2. AI LOUDNESS

The lowest and highest frequencies are enhanced according to the current volume setting. This function is effective when listening at low volume.

3. AI LINK (for use with DSP presence effects)

When the DSP F.4CH or DSP S.4CH function is selected, an equalizer curve which matches one of the six presence effects automatically to enhance the presence effect in use. (When the [EQ] key is pressed, "AI LINK" lights.)

4. Preset equalizer curve

Five curve patterns have been preset under M1 to M5. In addition, the "CAR AUDIO" curve for use in recording of a tape to be played on a car stereo and the "HP STEREO" curve for use in recording of a tape to be played on a headphone stereo are also prepared.

AI: Artificial Intelligence. The AI is capable of adjusting the tone automatically according to the source and music categories.

■ How to use the preset equalizer patterns

Any of the five preset equalizer patterns can be recalled easily. In case of double-speed recording, the equalizer curve is automatically modified accordingly.

1 Play a music source.

2 Select an equalizer pattern (refer to the next page).

① Press the [EQ.] key.



Main unit



Remote control unit

● Proceed to step ② below while the display is showing the input display (about 5 seconds).

② Select a pattern.

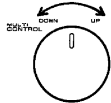

The patterns are switched over as shown in the diagram.
EQ OFF → EQ M-1 → EQ M-2 → EQ M-3 → EQ M-4 → EQ M-5
↑ HP STEREO ← CAR AUDIO ←

Press repeatedly.

To cancel the equalizer effect:

Set the EQ. to OFF.



(within 5 seconds)

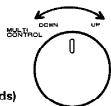

Main unit



Remote control unit

Press repeatedly.

■ Equalizer pattern list

Preset equalizer patterns (M1 ~ M5) The patterns in this mode adapt automatically to double-speed CCRS.	
M1 [Soft]:	For listening a soft sound comfortable for ears, like back ground music.
M2 [Clear]:	For listening a brilliant sound with reduced bass.
M3 [Heavy]:	For listening music like rock and fusion with more powerful sound.
M4 [Scale]:	For listening more exciting sound.
M5 [Noise reduction for use in double-speed recording]:	Cut off stimulating medium and high frequencies and enables soft sound recording.

M5: Noise reduction for use in double-speed recording.

The curve used in double-speed recording is opposite to the curve used in playback. Using these curves in recording and playback provides a noise reduction effect.

Double-speed recording curve

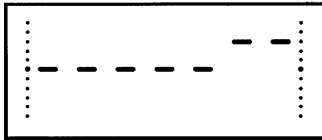

Playback curve

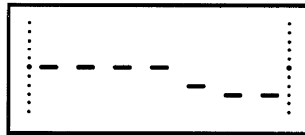

CAR AUDIO:	Records sound by optimizing the tone for playback on a car stereo.
HP STEREO:	Records sound by optimizing the tone for playback on a headphone stereo.

Operation of graphic equalizer

■ Operation of AI AUTO (available only for CD play)

By pressing the AI AUTO key only, the optimum equalizer pattern for a CD is selected automatically.

1 Place a disc in the CD player.

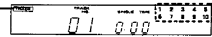
TRACK lights up  The track Nos. recorded on the CD are displayed.

2 Press the AI AUTO key.

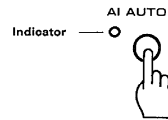

Sampling for compact disc

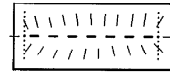

Completes and stops in about 20 sec.

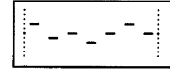

Graphic equalizer display

- Wait about 20 seconds until the blinking indicator lights up.

The playback starts automatically.

Note:
In step 2, the other keys than the **[AI AUTO]** key do not operate.

To cancel AI AUTO

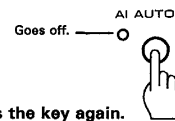

Press the key again.

or

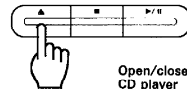

Open/close key of the CD player

- If it is canceled during AI AUTO setting operation, the last pattern selected before is displayed.

■ Operation of AI LOUDNESS control

This feature compensates automatically the lack of low and high frequencies felt when listening at a low volume.

To activate the AI LOUDNESS effect

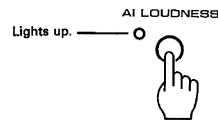

Lights up.

- To record with optional equipment, be sure to cancel the AI LOUDNESS function.

To cancel AI LOUDNESS

Press the key again.

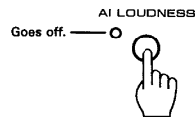

Goes off.

■ Recording with equalizer effect

1 Play music source and select a desired equalizer curve.

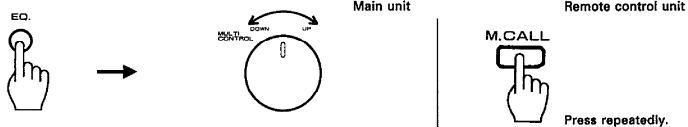

Perform while the display is showing the equalizer display (about 5 seconds).

- The equalizer curves are switched over in the order shown below:
EQ OFF → EQ M-1 → EQ M-2 → EQ M-3 → EQ M-4 → EQ M-5
 ↳ HP STEREO ← CAR AUDIO ←
- Select the desired curve from M1 to M5, CAR AUDIO and HP STEREO. (P.27)

2 Select the EQ. REC mode.

① Select the DSP OFF mode.

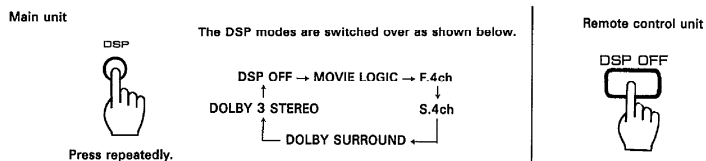

② Select the EQ. REC mode.

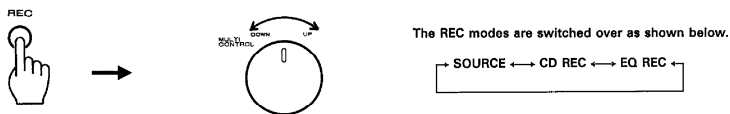

Perform while the display is showing the REC mode display (about 5 seconds).

- The equalizer effect is also applied to the signals output from the VIDEO REC and DAT REC jacks.

3 Start recording

Refer to page 39.

- It is useful to write a memo indicating the use of the equalizer pattern on the cassette tape.

To cancel EQ. REC: Set to the SOURCE mode.



Operation of CD player

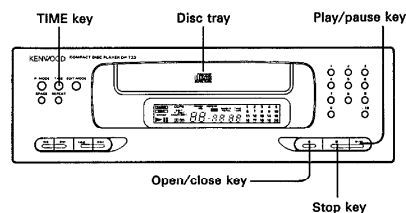

■ Playing a CD from the beginning (TRACK mode)

1 Select the CD input source on the preamplifier/tuner unit.

2 Insert a CD.

① Open the disc tray. ② Place a CD on the tray. ③ Close the tray.

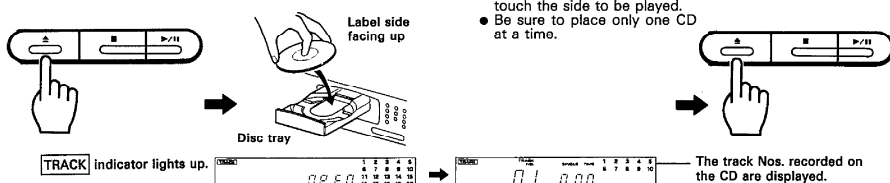

3 Start playback.

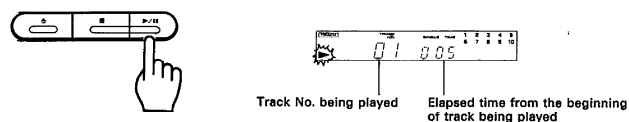

● In a few seconds, playback starts from track No. 1.

To pause CD play

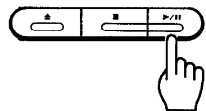

● To resume playback, press the key again.

To stop CD play

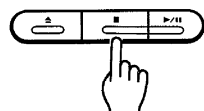

TIME key

Press the **TIME** key when you want to check the elapsed time and remaining time of the track being played. Every time the **TIME** key is pressed, the displayed time is switched as shown below. The time information display may not appear when playing a CD containing 44 or more tracks. In such a case, the display (remaining SINGLE TIME) will show "--:--".

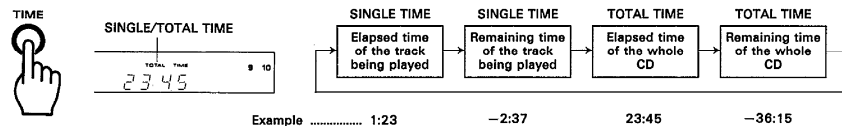

■ Starting play from a desired track

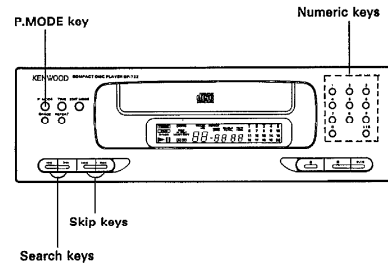

Selection using the skip keys

Press one of the skip keys according to which direction to skip.

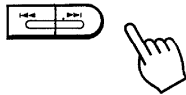

- Tracks are skipped in the direction of the pressed key, and playback resumes from the selected track.
- When the [SKIP] keys is pressed once during play, the track starts again from the beginning.

Selection using the search keys

Press the forward or reverse search key according to the direction to move.

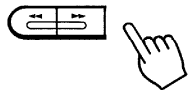

- The disc is fast-forwarded or fast-reversed while the corresponding side of the key is held pressed.
- Playback resumes from the position where the key is released.

Selection using the numeric keys

1 Ensure that the CD player is in the TRACK mode.

- If the [PGM] indicators is lighted, press the [P.MODE] key.

2 Select the desired track.

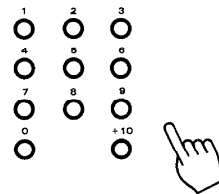

Examples of input

Track No. 3: **[3]**
 Track No. 23: **[+10] [+10] [3]**
 Track No. 40: **[+10] [+10] [+10] [+10] [0]**

- The selected track and also the tracks located after it will be played back.

Notes:

1. If a track No. which is not present on the CD is selected while the tray is open, the last track on the CD will be played.
2. Such a selection is not accepted after the tray has been closed or playback has started.

■ Playing desired tracks in desired order (PGM mode)

1 Enter the PGM mode.

Press the **[P.MODE]** key.

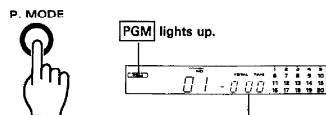

The SINGLE TIME (elapsed time) display changes to TOTAL TIME (remaining time) display.

2 Program desired tracks in desired order.

Example

To program track Nos. 2, 5 and 25: Press numeric keys **[2]**, **[5]**, **[+10]**, **[+10]** and **[5]** in this order.

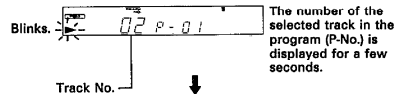

The number of the selected track in the program (P-No.) is displayed for a few seconds.



- Up to 20 tunes can be selected. When the 21 or more tunes are selected, "FULL" is displayed.
- If you made a mistake, press the **[CLEAR]** key (Remote control only) and select the correct track.
- Tracks can also be programmed by reading the disc label while the disc tray is open.
- The TOTAL TIME is not displayed in case a track No. of 44 or more is programmed.

3 Start playback.

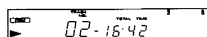
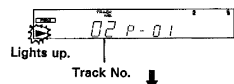
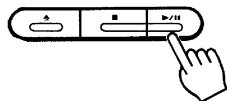

- Tracks are played in the order they are programmed (P-No.).
- Pressing one of the skip keys (**[▶▶]**, **[◀◀]**) during playback skips tracks in the corresponding direction.

To check the programmed order

Remote control only

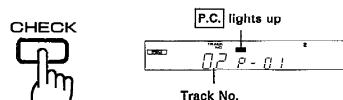

- Every time the key is pressed, the track No. and the order it was programmed (P-No.) are displayed in the order of programming.
- The previous display will resume in a few seconds.

To resume normal playback



- The playback in the order of the track Nos. on CD will start after the track being played.

To stop program play

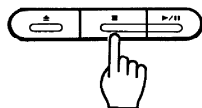

To check the time of each track on the disc.

In the program mode, when the disc is stopped, the time of each track on the disc can be checked by pressing the skip key **[▶▶]**.

- The previous display will resume in a few seconds.

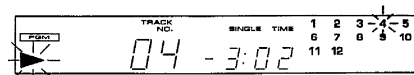

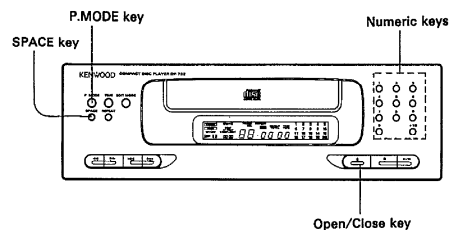
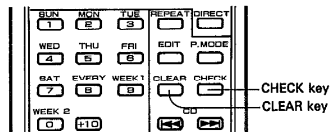

■ To add a track to the program

Press the key(s) for the track No. to be added.

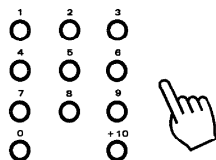

■ To clear tracks from the program

Clearing from the last track

Remote control only



- Every time the key is pressed, tracks are cleared from the last track in order.

■ To change a track in the program

1 Press the CHECK key. Remote control only



Press repeatedly until the program No. to be changed is displayed.

2 Press the keys for the track No. to replace the previous one.

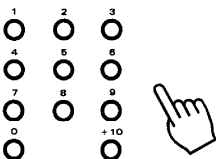

Press while the P.C. indicator is lighted.

- The track being played cannot be changed.

Clearing the whole of program

Press either key.

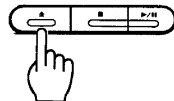

Auto-Space function

During playback in the program mode, when the [SPACE] key is pressed, a space of about 4 seconds is reserved automatically between the programmed tracks. This function is provided to facilitate the DPSS function of the cassette deck. However, such a space could also be reserved in case the sound of two tracks are continued, for example with some classic music and live recordings.



- The total time is displayed including the time of the space.
- To cancel Auto-space function, press the [SPACE] key again.
- This function does not operate in TRACK mode.

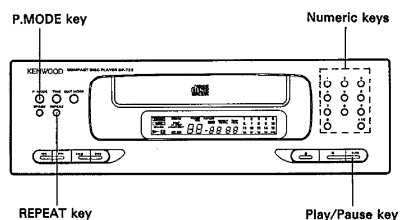

Repeat play

Repeating a program

1 Enter the PGM mode.
P. MODE
PGM lights up.

2 Select desired tracks.

- The whole of the program made up of the selected tracks will be played repeatedly.
- If only one track is selected, that track will be played repeatedly.

3 Press the REPEAT key.
REPEAT lights up.

4 Start playback.

Repeating a disc

1 Enter the TRACK mode.
P. MODE
TRACK lights up.

2 Press the REPEAT key.
REPEAT lights up.

3 Start playback.

To resume normal playback
Press the **REPEAT** key again.

REPEAT goes out.

- The playback will be resumed under the CD player mode set before the repeat.

Playback operation of cassette decks

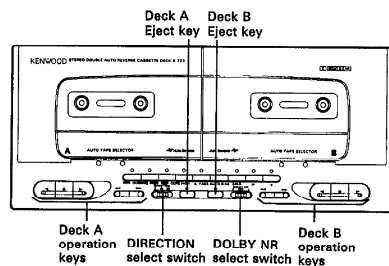

■ To playback a tape

1 Insert a cassette tape.

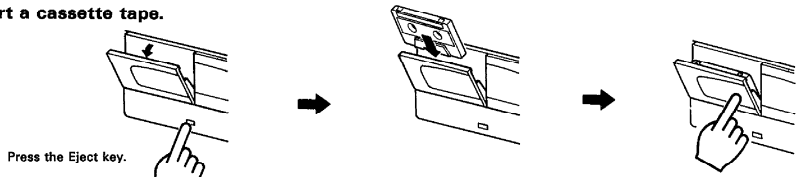

- The type of tape, Normal, Chrome or Metal, is detected and set automatically.
- Be sure to remove tape slack before insertion.

2 Determine the playback conditions.

① Select the playback mode.



- ∞ To play both sides endlessly.
- 2 To stop after playing both sides of tape.
- 1 To stop after playing one side of tape.

② Select the Dolby NR mode.



- Select according to the tape to be played.

3 Start playback.

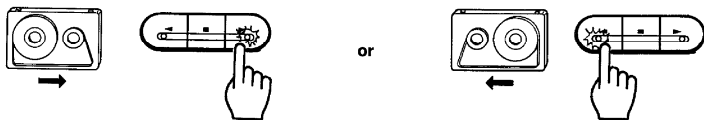

To stop playback, press the key.

- Do not press the Eject key until the tape has stopped completely.

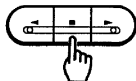

Dolby noise reduction system

The Dolby noise reduction system was developed to reduce the tape hiss noise generated during playback. The optimum effect of the Dolby NR system is obtained when the same type NR system is used for both recording and playback. If a different type NR system is used, playback is not performed correctly. Make sure that the same type noise reduction system is used for both recording and playback.

Dolby B NR:

The most popular noise reduction system used in home audio components. Usually, Dolby NR system corresponds to B NR.

Dolby C NR:

Dolby C NR offers improved noise reduction performance over that of the Dolby B NR. It features a superior noise reduction effect. Use Dolby C NR to record or playback with this unit.

It is recommended that tapes recorded with the Dolby NR system be marked "B" or "C", so that they can easily be distinguished.

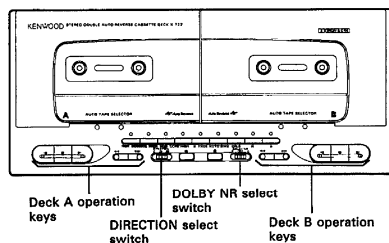

■ To wind the tape at high speed

1 Stop playback.

2 Press the ◀◀ key or ▶▶ key.

◀◀ : Fast tape winding in the ← direction ▶▶ : Fast tape winding in the → direction

To stop fast tape winding

Tape direction indicators
 The direction in which tape is transported during playback or recording is indicated by the lighting of one of the indicators ◀ and ▶. The direction used before the last time the tape is stopped is held in memory even after the power is turned OFF, so the same direction is recalled the next time the power is turned ON. To change the tape direction, press the Play key of the opposite direction after having inserted the cassette.

■ Relay playback

The relay playback allows to play two tapes in decks A and B alternately and repeatedly.

1 Insert tapes.

- The tapes are played in the directions indicated by their respective indicators.

2 Select the playback mode.

◁ ▷ Relay playback of both sides of tapes in decks A and B is repeated.
 — Relay playback of only one side of tapes in decks A and B is repeated.

- Relay playback cannot be performed if the DIRECTION select switch is set to "◁ ▷".

3 Start playback.

- The playback starts with the deck the play key of which is pressed.

DPSS operation

The DPSS stands for Direct Program Search System, which enables the following convenient operations (these operations are, however, not available on both decks simultaneously). The DPSS functions are based on the detection of non-recorded spaces of 4 seconds or more between tunes.

- 1. Skip play:** By specifying a tune located several tunes beyond (or behind) the tune being played, skips tunes between the current tune and the desired tune and starts playback from the beginning of the selected tune. Up to 16 tunes can be skipped in Skip Search.
- 2. Rewind & Play:** Rewinds the tape to the beginning and starts playback from there.
- 3. Single-tune repeated playback:** One single tune is played back repeatedly up to 16 times.
- 4. Dash & Play:** If a non-recorded space of more than 10 seconds is detected during playback, that space will be skipped by fast tape winding.

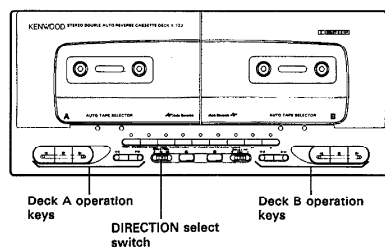
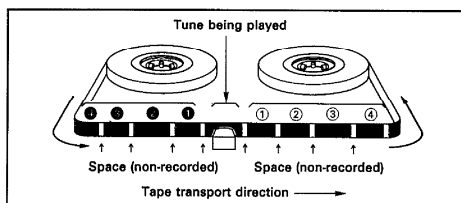

■ Skip play operation

The example below shows the case in which the direction indicated by the tape transport direction indicator is ▶.

If the direction indicated by the tape direction indicator is ◀, always press the keys for the opposite directions to those shown in the illustrations below.

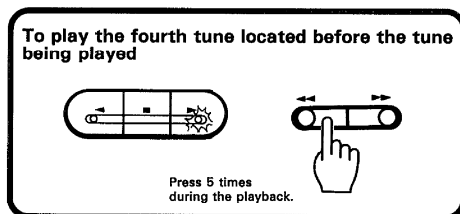
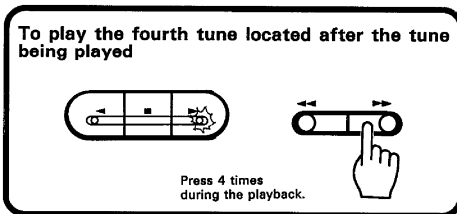
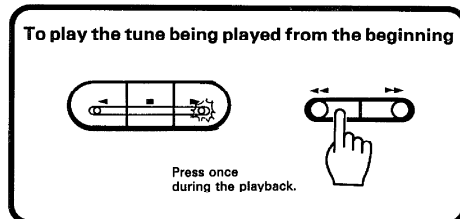
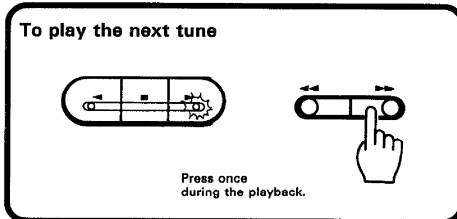

The DPSS will not function properly with the following types of tapes.

- Tapes containing spaces of 4 seconds or more, such as conversations and speeches.
- Tapes containing extremely low levels or non-recorded blanks in the middle of tunes, such as classical music.
- Tapes containing recording or large noise between tunes.
- Tapes containing spaces of less than 4 seconds between tunes.
- Tapes recorded with low recording level.
- Tapes recorded using Cross-fade recording.

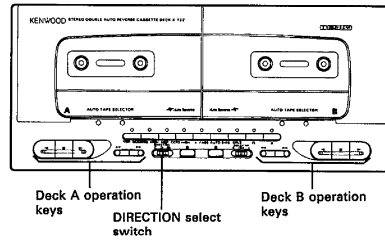

■ Rewind & Play operation

This operation is not available from the remote control unit.

Direction of tape direction indicator: ▶

Press simultaneously.

Direction of tape direction indicator: ◀

Press simultaneously.

■ Single-tune repeated playback operation

1 Play the tune to be repeated.

2 Press the play key of the same direction as the current tape transport direction.

Direction of tape direction indicator: ▶

- Normal playback resumes after repeating the same tune for 16 times.

■ Dash & Play operation

The Dash & Play skips long non-recorded spaces automatically as the tape is played.

This operation is not available from the remote control unit.

1 Determine the playback mode (conditions).

- ◁ ... Two sides are repeated 8 times, after which playback stops.
- ▷ ... Two sides are repeated only once, after which playback stops.
- ↔ ... One side is repeated 8 times, after which playback stops.

- In case the DIRECTION select switch is set to "↔" and tapes are inserted in both of the decks, when a deck finishes Dash & Play, the other deck starts Dash & Play for 16 times, after which it stops.

2 Press the ◀◀ and ▶▶ keys simultaneously.

To cancel the playback above in the middle

- Playback stops.

Recording operation on cassette deck (Deck B only)

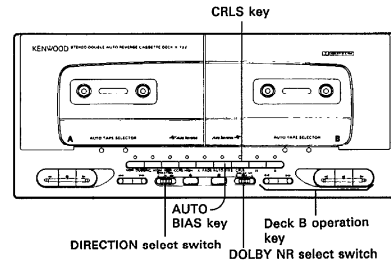

■ Ordinary recording

<p>1 Set up the cassette deck.</p> <p>① Insert a tape in deck B.</p> <p>② Set the tape transport direction.</p> <p>③ Select one-side or two-side recording.</p> <p>④ Select the Dolby NR mode.</p> <ul style="list-style-type: none"> When the microphone is not to be used, be sure to set the MIC MIXING control fully counterclockwise. 	<p>4 Set the auto bias adjustment function.</p> <ul style="list-style-type: none"> The optimum bias value is set in about 45 seconds, after which the deck stops the auto bias operation. To cancel the auto bias adjustment operation in the middle, press the Stop key. It is also possible to start recording without performing the auto bias adjustment. <p>5 Adjust the recording level.</p> <p>① Play the musical source and output its sound.</p> <p>② Press the [CRLS] key.</p> <p>Level adjustment completes in about 20 seconds. Wait until the indicator lights steadily.</p> <ul style="list-style-type: none"> The deck enters the record-pause mode. When the [CRLS] key is pressed after the indicator has lighted up and level adjustment has completed, the search operation of CRLS restarts from that moment for 20 seconds. If you press the Record key while the indicator is blinking, the recorded sound may distort. When the [CRLS] key is pressed while the indicator is blinking, the level adjustment is terminated at that moment and the deck enters the record-pause mode. The recording level setting is suspended if the sound of source is not input within about 5 second after the [CRLS] key has been pressed. <p>6 Start recording.</p> <p>① Play the music source from the beginning.</p> <p>② Press [RECORD] the key.</p> <p>Press once.</p> <ul style="list-style-type: none"> Recording will start. The deck enters the stop mode automatically when the tape has been recorded till the end.
<p>2 Select the source to be recorded.</p> <ul style="list-style-type: none"> Select a music source other than TAPE. 	
<p>3 Check the REC mode.</p> <ul style="list-style-type: none"> For EQ. REC, refer to page 29. For CD REC, refer to page 41. For PRESENCE REC, refer to page 55. Select SOURCE to record the source sound without processing it with the equalizer. 	

Auto bias adjustment function
 Normal tapes are available in wide ranges, from popular products to high-class products, and their characteristics vary largely. The cassette deck incorporates the auto bias adjustment function enabling optimum recording for normal tapes. It is recommended to use the auto bias adjustment function when recording using a Normal tape.

- During auto bias adjustment operation, operation keys are not effective except for the Fast forward, Rewind and Stop keys of deck A and the Stop key of deck B.
- If the remaining amount of tape is small, the auto bias adjustment may be canceled in the middle and tape may stop there.
- The setting of auto bias adjustment is canceled when the Eject key of Deck B is pressed.

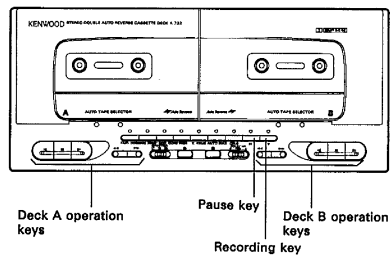

■ To pause recording temporarily

● The indicator lights up.

To resume recording

■ To re-start recording after mistake

The following procedure is useful when you want to cancel recording in progress and restart it. A non-recorded space of 4 seconds or more should be reserved before the position where recording was started.

1 Stop recording and rewind tape.

During recording in the ► direction:

During recording in the ◀ direction:

● The recording is aborted, the tape is rewound to the position where the recording was started, and the deck enters the stop mode after leaving a non-recorded space of about 2 seconds from the end of the previous tune.

2 Re-start recording.

① Press the key twice.

● A non-recorded space of 4 seconds is reserved on tape, then the tape transport stops.

② Press the key once.

● Recording starts.

■ To stop recording

1

Press once.

2 Stop playing the source component.

Note:
Do not press the MUTE key in the remote control unit.

CRLS
CRLS (Computer-controlled Recording Level System):
This function sets the optimum recording level automatically based on the sampling of the levels of a musical source for about 20 seconds.

- Even when you do not press the [CRLS] key Recording is performed with the basic recording level. The basic recording level common for all input select keys has been set at the factory.
- The level is stored in memory once it has been set The level determined by the [CRLS] key for each input source (DBS/LD, VIDEO, DAT, TUNER, CD) is stored in memory. From the next time, the same level is recalled for the same source and applied for recording even when the [CRLS] key is not pressed.
- To re-use the previous level after having pressed the [CRLS] key Press the Stop key while the CRLS indicator is blinking to re-use the previously-set level.
- When the [CRLS] key is held depressed for more than 3 seconds The indicator blinks at low speed then goes out. At this time, the CRLS level which has been stored for the input source being indicated returns to the basic recording level.

■ Synchro recording of CD playback

The cassette deck and the CD player can started simultaneously.

1 Set up the cassette deck.

- ① Insert a tape in deck B.
- ② Set the tape transport direction.
- ③ Select one-side or two-side recording.

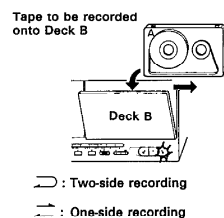

- ④ Select the Dolby NR mode.

2 Activate the auto-bias setting.

- The optimum bias is set in about 45 seconds, after which the deck enters the stop mode.

3 Check the REC mode.

- For EQ. REC, refer to page 29.
- For CD REC, refer to page 41.
- For PRESENCE REC, refer to page 55.
- Select SOURCE to record the source sound without processing it with the equalizer.

4 Adjust the recording level.

- ① Start playing the CD.

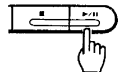

- ② Press the [CRLS] key.

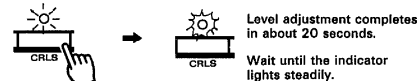

- The deck enters the record-pause mode.

- ③ To pause CD play

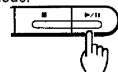

5 Start playing the CD.

- ① Select the desired tracks with the numeric key.
- ② Start playback.

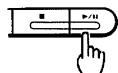

- Tape recording starts at the same time.
- When the CD player has completed playback, the cassette deck also stops recording and enters the stop mode.

To pause

Press the [⏸] key of the CD player.

To resume recording

Press the [⏸] key of the CD player.

To stop recording

Press the [⏹] key of the CD player.

- When the [⏹] key on the cassette deck is pressed, the cassette deck enters the stop mode, but the playback of CD does not stop.

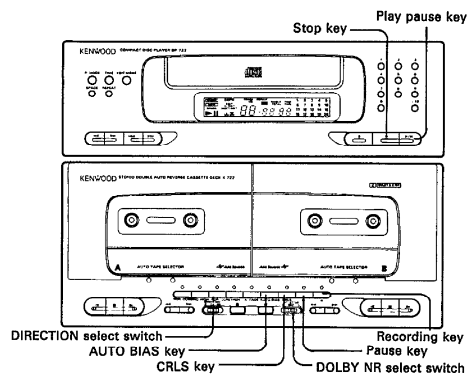

■ How to CD REC

Another music source can be played back while recording CD.

1 Select the CD REC mode.

- ① Press the [REC] key.

Proceed to step ② below while the display is showing the REC mode display (about 5 seconds).



- ② Select the CD REC mode.

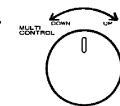

2 Record a CD.

Refer to "Synchro recording of CD playback" and "Recording of CD playback (CCRS)".

3 Select the desired source to be listened to.

To cancel CD REC

Press so that the CD REC indicator is extinguished.

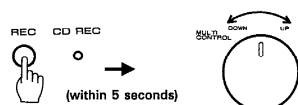

- The key is not accepted while the record indicator is lighted up or blinking.

Notes:

1. The equalizer effect cannot be applied to CD recording while CD REC is ON.
2. Do not forget to cancel CD REC after operation.

Recording of CD playback (CCRS)

The CCRS (Computer-controlled CD Recording System) makes the following convenient recordings possible by setting the optimum tape recording level and recording bias for the specific CD to be recorded and starting recording automatically. (CCRS recording is available only with Deck B.)

Recording of TRACK mode playback: CCRS starts recording the CD tracks from the first track in order. When the end of one tape side is reached during recording, fade-out occurs there, and recording is continued on the other side of tape, which starts with fade-in.

Recording of PGM mode playback: CCRS starts recording the programmed CD tracks in the programmed order. When the end of one tape side is reached during recording, the track which should end in the middle is erased, and the recording on the other side of tape is started from that track.

Normal EDIT recording: When the recording time of the tape is specified first, the order of the CD tracks are edited so that no track is interrupted at the end of each side of tape. The maximum number of tracks that can be edited is 20.

AI EDIT recording: When the total playing time of a CD exceeds the recording time of tape, all tracks can still be accommodated in the tape by fading out the end of each track.

MULTI EDIT recording: Tracks on multiple CDs can be edited and accommodated in a single tape.

X.FADE (Cross-fade) recording: The beginning and end of each track is faded in/out to create a music tape without interruption between tunes.

CCRS double-speed recording: Records CD at twice the normal speed. The graphic equalizer provides patterns for use in double-speed recording.

Also, refer to "Operation of CD player".

CCRS (Computer-controlled CD Recording System)

When the **CCRS** key is pressed, the following operations occur automatically and recording of CD starts after them.

1. The CD is played and its peak level is sampled from the level used when the disc was recorded.
2. The optimum recording level for that disc is determined from the sampled peak level and the cassette deck is set accordingly.
3. The cassette deck sets automatically the optimum bias for the tape used in recording.
4. The recording preparations detailed above are completed in about 90⁺ seconds, after which actual recording starts.
5. When the recording is completed (when the CD player ends playback or when the tape has been recorded), both the cassette deck and CD player enter the stop mode.

- The set recording level and auto bias level are maintained while the CCRS and AUTO BIAS indicators are lighted.
- The recording level is canceled when the open/close key of the CD player is pressed, the auto bias level is canceled when the Eject key of Deck B is pressed, and both are canceled if the power is turned off.

Indications on the cassette decks during CCRS operation

Indicator	Lighting ○ Blinking ☼ OFF ●			
	CCRS	AUTO BIAS	Pause	Recording
During recording level setting	☼ Quick blinking	●	○	○
During auto bias adjustment	☼	☼	●	○
	☼	☼	●	●
During recording	☼ Slow blinking	○	●	○
During record-pause	○ *1	○ *2	●	●

- * 1. To cancel CCRS setting: Press the Tray open/close key of the CD player.
- * 2. To cancel auto bias setting: Press the Eject key of the cassette deck.
- * 3. The time varies according to the number of the tunes to be recorded.

Fade-in and fade-out

Fade-in refers to a gradual increase of volume from the minimum to normal level when starting to play music. Inversely, fade-out refers to a gradual decrease of volume from the normal to minimum level at the end of music.

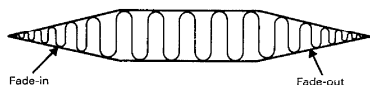

CCRS double-speed recording

CD and cassette deck are both played at twice the normal speed and recorded, making it possible to half the time required for recording. Since the CD is played in double speed in this case, the recorded content cannot be enjoyable as music even though it can be monitored from the speakers.

To record with a graphic equalizer effect in double-speed mode, be sure to select one of the preset patterns.

In double-speed recording, tunes are recorded onto the tape without DOLBY NR effect. So playback the tape without DOLBY NR effect.

■ Recording of CD playback in TRACK mode

Fade-out and fade-in occur at the end of tape where it is reversed.

1 Select CD with the input selector, and place a CD in the tray.

2 Perform "Ordinary recording" until step 3.

- Refer to page 39.

3 Check that the CD player is in the TRACK mode.

- If the [PGM] indicator is lighted up, press the [P. MODE] key.

4 Start recording.

Normal-speed recording

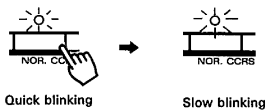

Double-speed recording

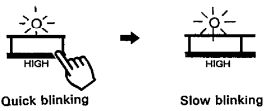

- The CCRS is activated so the recording will start in about 90 seconds.
- The tracks on the disc are recorded in the order of the track Nos.
- The operations as shown below occur at the end of tape where it is reversed.

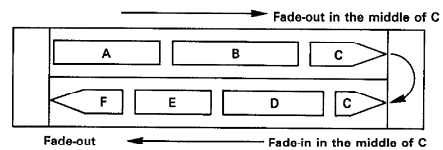

■ Recording of CD playback in PGM mode

Tracks are recorded so that they do not end in the middle at the end of tape.

1 Select CD with the input selector, and place a CD in the tray.

2 Perform "Ordinary recording" until step 3.

- Refer to page 39.

3 In the PGM mode, select the order of tracks to be played.

- Refer to page 32.

4 Start recording.

Normal-speed recording

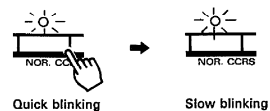

Double-speed recording

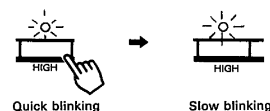

- The CCRS is activated so the recording will start in about 90 seconds.
- The tracks on the disc are recorded in the programmed order.
- The operations as shown below occur at the end of tape where it is reversed.

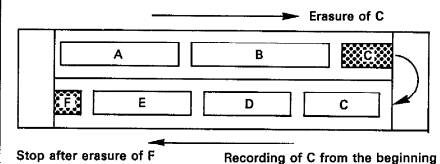

Notes:

- When the [CCRS] key is pressed during CD playback, the playback is stopped and CCRS setting operation starts.
- Once the recording level has been set by the CCRS, it cannot be adjusted as long as the CCRS operation continues.
- The CCRS searches the peak level on a CD in a limited period of about 90 seconds. Therefore, it could happen that the optimum level cannot be adjusted, though it is a very rare case.
- The recording level set by the CCRS is canceled when the Tray open/close key of the CD player is pressed or the power is turned off.
- If the length of a track on the CD is extremely long such as with a classical music, the CCRS cannot be used because the music cannot be fit in one side of tape.
- If a tune beginning and ending with fade-in and fade-out is recorded by X-FADE recording, spaces between recorded tunes may become very long.
- When the [DIRECTION] select switch of the cassette deck is "→" the tape end processing occurs only on the A side of tape.
- The CCRS and auto bias adjustment functions may not work properly near the end of tape.
- During CCRS operation, operation keys are not effective except for the Stop key of cassette deck and the stop key and Tray open/close key of CD player.

Normal EDIT recording

This function allows to edit, base on the recording time of the tape specified, the order of the CD tracks so that no track is interrupted at the end of each side of tape.

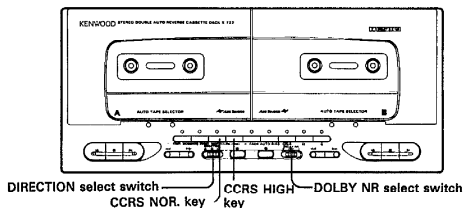

1 Set up Deck B ready for recording.

① Insert the cassette tape.

② Check the tape transport direction.

③ Select the tape sides to be recorded.



④ Select the Dolby NR mode.

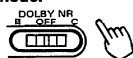

2 Check the REC mode.

- For EQ. REC, refer to page 29.
- For CD REC, refer to page 41.
- For PRESENCE REC, refer to page 55.
- Select SOURCE to record the source sound without processing it with the equalizer.

3 Select the CD input.

4 Insert the disc in the CD player.

- When you wish to program tunes, carry out the programming before step 5.
- To use the auto space function (page 33), press the **[SPACE]** key.

5 Select the EDIT mode with the EDIT MODE key of the CD player.

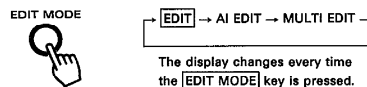

- Proceed to the next step within 8 seconds after setting EDIT. If 8 seconds have elapsed, select the EDIT mode again.
- The CD playback mode is set automatically to **[PGM]**.

6 Input the two-way recording time of the tape.

Use the numeric keys of the CD player.

C-30 tape: **[+10] [+10] [+10] [0]**

C-48 tape: **[+10] [+10] [+10] [+10] [6]**

- 46, 54, 60 or 90 can also be selected every time the **[TIME]** key is pressed. In this case, press the **[EDIT MODE]** key again to establish the input.
- Tracks are edited automatically to fit sides A and B, and the end of editing is indicated when the **[EDIT]** indicator changes from blinking to continuous lighting.
- If a program containing a few tracks has been programmed previously, these tracks can be recorded in priority.
- When the **[EDIT MODE]** key is pressed again while **[EDIT]** is lighted, "SHUFFLE" appears on the display and re-editing of tracks is performed.

7 Press the CCRS key.

Normal-speed recording

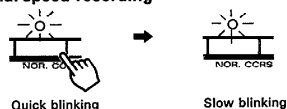

Double-speed recording

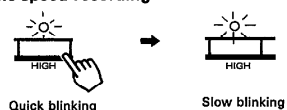

Recording occurs as shown below.

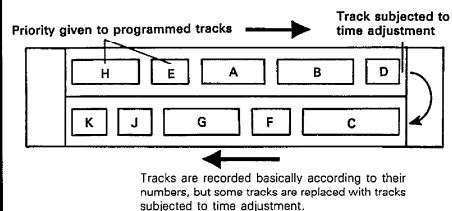

- The CD player and cassette deck enter the stop mode automatically after the completion of recording.

Notes:

1. Edit operation does not occur if a track No. 44 or more has been programmed.
2. Repeat playback is not available.
3. To cancel the auto-spacing, press the **[P.MODE]** key and re-start the procedure from step 5.

AI EDIT recording

When the total playing time of a CD exceeds the recording time of tape, this function allows to accommodate all tracks in a tape by cutting the end of each track by means of fade-out. It is also possible to specify the important tracks that must not be cut.

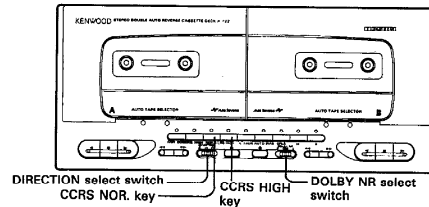

1 Set up Deck B ready for recording.

- ① Insert the cassette tape.
- ② Check the tape transport direction.
- ③ Select the tape sides to be recorded.

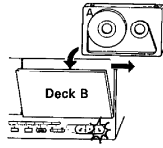

→ Select two-side recording.

- ④ Select the Dolby NR mode.

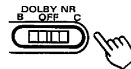

2 Check the REC mode.

- For EQ. REC. refer to page 29.
- For CD REC. refer to page 41.
- For PRESENCE REC. refer to page 55.
- Select SOURCE to record the source sound without processing it with the equalizer.

3 Select the CD Input.

4 Insert the disc in the CD player.

5 Select the tracks which must not be cut in recording.

- ① Press the **[P.MODE]** key.
 - **[PGM]** lights up.
- ② Input the track Nos. using the numeric keys.
 - Input several numbers in a desired order.
 - For details, refer to "Playing desired tracks in desired order" on page 32.

6 Select the AI EDIT mode with the EDIT MODE key of the CD player.

EDIT MODE

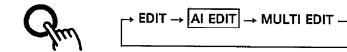

The display changes every time the **[EDIT MODE]** key is pressed.

- Proceed to the next step within 8 seconds after setting AI EDIT. If 8 seconds have elapsed, select the AI EDIT mode again.

7 Input the two-way recording time of the tape.

Use the numeric keys of the CD player.

C-30 tape: **[+10] [+10] [+10] [0]**

C-46 tape: **[+10] [+10] [+10] [+10] [6]**

- 46, 54, 60 or 90 can also be selected every time the **[TIME]** key is pressed. In this case, press the **[EDIT MODE]** key again to establish the input.
- Tracks are edited automatically to fit sides A and B, and the end of editing is indicated when the AI EDIT indicator change from blinking to continuous lighting.

8 Press the CCRS key.

Normal-speed recording

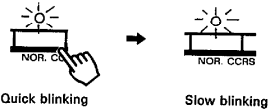

Double-speed recording

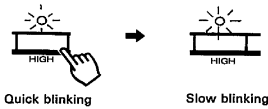

Recording occurs as shown below.

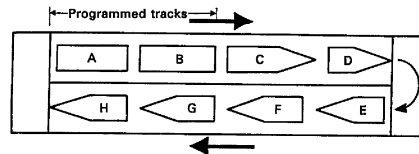

- First, the programmed tracks are recorded without any cutting, the other tracks are recorded with the end of every track cut by fade-out.
- If the tape has enough recording time, all tracks are recorded until the end.
- The CD player and cassette deck enter the stop mode automatically after the completion of recording.

Notes:

1. If an extremely-short tape recording time is set, automatic editing may not occur, or the tracks that must not be cut may cut.
2. The **[SPACE]** key and **[REPEAT]** key functions are inoperative.
3. Edit operation does not occur if a track No. 44 or more has been programmed.
4. X.FADE recording is not possible.

■ MULTI EDIT (Multiple disc edit) recording

This function allows to edit desired tracks on multiple CDs, each of which containing no more than 20 tracks, and record them on a single tape while replacing discs.

1 Set up Deck B ready for recording.

- ① Insert the cassette tape.
- ② Check the tape transport direction.
- ③ Select the tape sides to be recorded.
 ⇨: Select two-side recording.
- ④ Select the Dolby NR mode.

2 Check the REC mode.

- For EQ. REC, refer to page 29.
- For CD REC, refer to page 41.
- For PRESENCE REC, refer to page 55.
- Select SOURCE to record the source sound without processing it with the equalizer.

3 Select the CD input.

4 Insert the disc in the CD player.

5 Select the MULTI EDIT mode with the EDIT MODE key of the CD player.

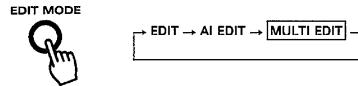

The display changes every time the [EDIT MODE] key is pressed.

- Proceed to the next step within 8 seconds after setting MULTI EDIT. If 8 seconds have elapsed, select the MULTI EDIT mode again.
- The CD playback mode is set automatically to [PGM].

6 Input the two-way recording time of the tape.

Use the numeric keys of the CD player.
C-30 tape: [+10] [+10] [+10] [0]
C-46 tape: [+10] [+10] [+10] [+10] [6]

- 46, 54, 60 or 90 can also be selected every time the [TIME] key is pressed. In this case, press the [EDIT MODE] key again to establish the input.
- [MULTI EDIT] changes from blinking to continuous lighting, indicating the program input stand-by, and the recordable time of side A is displayed.

7 Select the tracks to be recorded.

Using the numeric keys of the CD player, input the track Nos. in the order they are to be recorded.

- The TOTAL TIME display shows the remaining time on tape side A or B.
- When "FULL" appears on the display, this indicates that tracks cannot be recorded any more.

8 Press the CCRS key.

Normal-speed recording

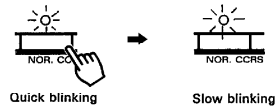

Double-speed recording

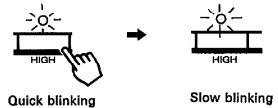

Recording occurs as shown below (example when three CDs are to be recorded).

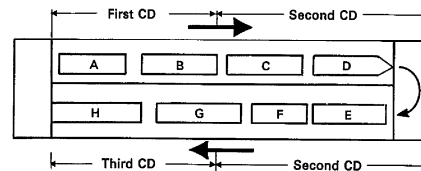

- When the first CD has been recorded, both the CD player and cassette deck enter the stop mode, and the tray of the CD player opens automatically.
- To record the second and third CDs, repeat steps 7 and 8 after changing the CDs and closing the tray of the CD player.

Notes:

1. In step 7, the display of the CD player shows FADE and the end of the selected tune which is longer than the preset time is faded out.
2. Track No. 44 or more cannot be input.
3. The [SPACE] key and [REPEAT] key functions are inoperative.
4. X.FADE recording is not possible.

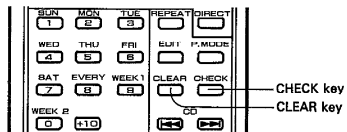

■ To check the edited contents

Remote control only

● Every time the key is pressed, the track Nos. are displayed in the edited order.

● Only the track Nos. on the disc being present in the CD player are displayed in case of MULTI EDIT.

■ To clear the edited contents

Clearing individual tracks from the last track (MULTI EDIT only) Remote control only

● Every time the key is pressed, the last track in the edited sequence of tracks is cleared.

● Only the track on the disc being present in the CD player can be cleared.

Clearing all edited contents Press either of the following keys of the CD player.

● Only the track on the disc being present in the CD player can be cleared in case of MULTI EDIT.

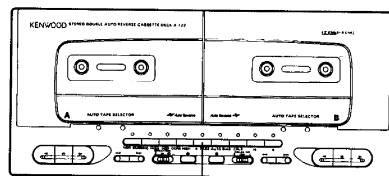

X. FADE Key

■ X.FADE recording of CD playback

Not available with double-speed recording

1 Select CD with the input selector, and place a CD on the tray.

2 Perform "Ordinary recording" until step 3.
● Refer to page 39.

3 Start recording.

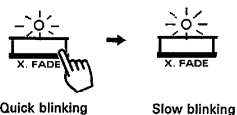

- The CCRS is activated so the recording will start in about 90 seconds.
- The recording operation according to the mode of the CD player starts.

In case of TRACK or PGM mode

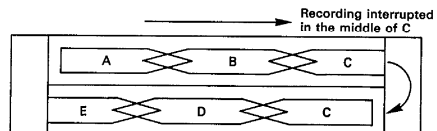

Stop in the middle of E Recording of C from the beginning

In case editing (Normal EDIT) is executed before recording

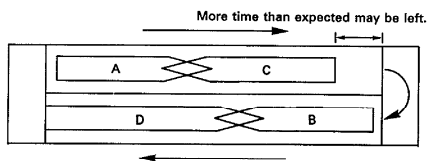

Tape dubbing

The dubbing refers to the copy of the recorded contents of a tape to another tape (tape in Deck A → tape in Deck B).

Normal-speed dubbing: Copy at normal tape speed.
High-speed dubbing: Copy at double the normal speed.

1 Insert tapes in the cassette decks.

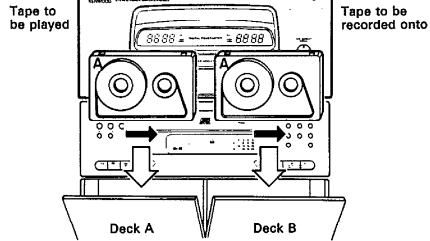

2 Set the same tape transport direction for both tapes.

- Refer to page 36.



3 Select one-way or two-way dubbing mode.

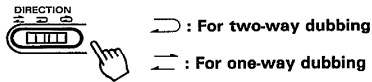

4 Press the AUTO BIAS key.

- The optimum bias is set in about 45 seconds, after which the cassette decks enter the stop mode.

5 Start dubbing.

For normal-speed dubbing

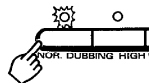

For high-speed dubbing

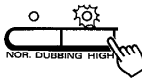

DUBBING NOR. key

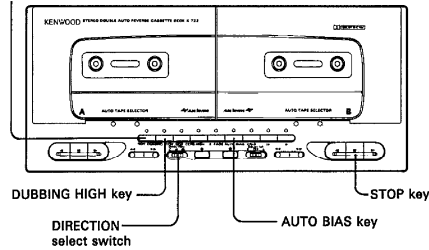

To stop dubbing Press the Stop key of Deck B

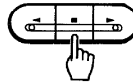

- Both Decks A and B enter the stop mode.

To pause dubbing

Normal-speed dubbing: Press the **[NOR.]** key.
High-speed dubbing: Press the **[HIGH]** key.

- Only deck B enters the record-pause mode after leaving a non-recorded space of about 4 seconds in case of normal-speed dubbing, or about 6 seconds in case of high-speed dubbing.
- To skip tunes you do not want to dub on another tape during dubbing, press the **[SKIP]** key of Deck A.
- To resume dubbing after pause, press the same DUBBING key as above (**[NOR.]** or **[HIGH]**) again.

Notes:

- The recording level cannot be adjusted for dubbing.
- The **[DOLBY NR]** switch does not function during dubbing.
 - * The tape recorded by dubbing features the same NR system as the original tape in Deck A.
- Noise from TV may interfere with dubbed sound if high-speed dubbing is executed near a TV set. To prevent this, install the system farther from the TV set.
- If the original tape was recorded at a high level, the sound quality may be degraded if high-speed dubbing is used. In such a case, use normal-speed dubbing.

Simple Karaoke singing entertainment

HIT MASTER: This key allows reduce the vocal of songs played on CD, etc., so that you can sing along with only the accompaniment just like in "Karaoke" singing. This feature is convenient when you want to master a latest song the "Karaoke" backing of which is not available.

• HIT MASTER does not function in Dolby surround or 3-stereo mode.

■ Connecting a microphone

1 Turn the MIC MIXING control fully counterclockwise.

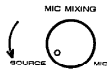

2 Insert the microphone plug into the MIC jack.



3 Adjust the volume.

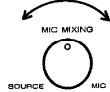

■ Singing "Karaoke"

1 Play the music source.

2 Press the HIT MASTER key.

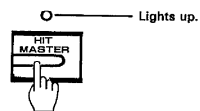

• Only the vocal part is reduced from the music source. However, note that this effect cannot be obtained with certain types of sources.

3 Sing along with the music.

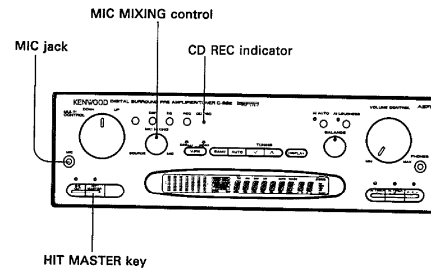

■ Recording "Karaoke"

1 Connect a microphone.

2 Perform the "Ordinary recording" procedure until step 5.

• Refer to page 39.

3 Ensure that the CD REC is OFF.

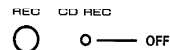

4 Press the HIT MASTER key.

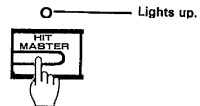

5 Start recording.

① Play a music source.

② Press the record key.

③ Sing along with the music.

• A "Karaoke" accompaniment tape can also be created by recording music with the MIC MIXING control set fully counterclockwise.

6 Stop recording.

Notes:

- When the microphone is not to be used, be sure to set the MIC MIXING control fully counterclockwise.
- The mixture of microphone sound and tape playback sound cannot be recorded.

Presence effect

This unit incorporate features the following which can provide the feeling of presence which surrounds us in concert halls and theaters, and the powerfulness of movies played in movie theaters equipped with Dolby Surround system. For details, please refer to operating procedures described on the subsequent pages.

Types of DSP modes

DSP F.4CH

The built-in presence speakers function to reproduce six kinds of presence effects (discotheque, movie theater, arena, church, jazz club, stadium) from the front speakers only. It is also possible to create desired sound fields by fine adjustment. (See Figure-4.)

DSP S.4CH

Select this mode when the center speaker and surround rear speakers are connected. Six kinds of presence effects can be reproduced similarly to DSP F.4CH. (See Figure-1.)

AI LINK equalizer effect

When DSP F.4CH or DSP S.4CH is selected, equalizer curves are automatically created according to the six kinds of presence sound fields to enhance them.

MOVIE LOGIC

Allows to enjoy a sound field like in a movie theater without using the center speaker and surround rear speakers. (See Figure-4.)

DOLBY SURROUND PRO LOGIC

When video software tape or LD software disc marked [DOLBY SURROUND] is played, a Dolby Surround effect similar to movie theaters can be enjoyed. (See Figures-1 and 3.)

DOLBY 3 STEREO

Select this when the surround rear speakers are not used. This improves the positioning of the center sound. (See Figure-2.)

ASFC (Acoustic Surround Field Control)

Adjust the sound expansion to improve the presence effect when the center speaker and surround rear speakers are not used. (For DSP F.4CH only.)

PRESENCE REC

Applies DSP presence sound field effect to the recording of music on the cassette deck. This allows to enjoy the DSP sound on headphone stereo and car stereo. (For DSP F.4CH, DSP S.4CH only)

DSP (Digital Signal Processor)

The DSP system converts the reverberation components which enhance the presence effects into digital signals, and provides various presence effects without spoiling the quality of music sources.

■ Speaker layout

Standard layout

DOLBY SURROUND PRO LOGIC mode. (NORMAL, WIDE)
DSP S.4CH mode

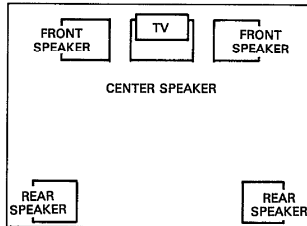

Figure-1

When the surround rear speakers are not used

DOLBY 3 STEREO mode

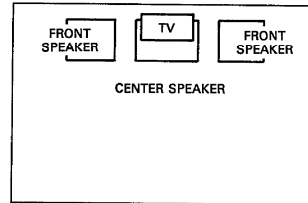

Figure-2

When the center speaker is not used

DOLBY SURROUND PRO LOGIC mode (PHANTOM)

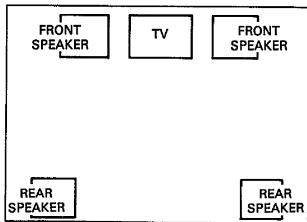

Figure-3

When only two speakers are used

MOVIE LOGIC mode
DSP F.4CH mode

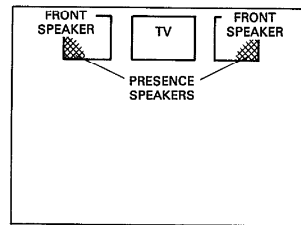

Figure-4

Note:

The built-in presence speakers function only in MOVIE LOGIC and DSP F.4CH modes.

How to set the delay time **DOLBY SURROUND PRO LOGIC only**

The delay time should be adjusted according to the difference between the distances from the listening position to the front speakers and that from the listening position to the surround rear speakers. Refer to the following formula for the delay time adjustment.

Relationship between the surround rear speaker positions and the delay time at listening position:

$$\text{Delay time} = 20 \text{ ms} + 3 \text{ ms} \times (A \text{ m} - B \text{ m})$$

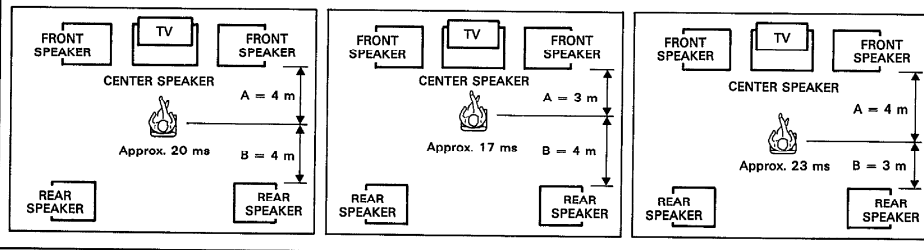

Dolby Surround and Dolby 3 Stereo adjustments Remote control only

1 Activate the Dolby Surround (Pro Logic) or 3 Stereo mode.

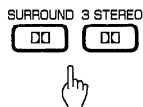

2 Select the center mode.

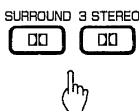

In Surround (Pro Logic mode): Press repeatedly.

Each press switches the center mode as shown below:

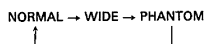

In 3 Stereo mode:

Each press switches the center mode as shown below:

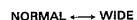

- Select the NORMAL mode when the center speaker is of a compact size, and the WIDE mode when it is of a medium or larger size.
- Select the PHANTOM mode when the center speaker is not used.

3 Generate the test tone.

Pressing the **TEST TONE** key once moves the noise-like test tone between speakers every two seconds (for use in adjustment), and pressing the key twice moves it every second (for use in checking). The test tone is turned off by the third press.

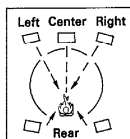

In NORMAL or WIDE mode:

The test tone moves in order of Left → Center → Right → Rear.

In PHANTOM mode:

The test tone moves in order of Left → Right → Rear.

4 Adjust the speaker volumes so that the levels from all speakers are identical.

① Adjust the center level.

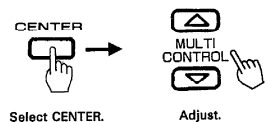

② Adjust the rear level.

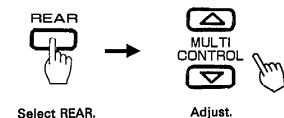

- In the 3 Stereo mode which does not use the rear speakers, adjust so that the volumes from the three front speakers are identical.

5 Switch the test tone off.

Press the **TEST TONE** key again.



6 Adjust the delay time.

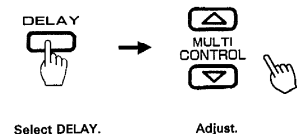

- The delay time is not set in the 3 Stereo mode.
- Refer to the formula shown on page 51.

DSP presence

The DSP (Digital Signal Processor) allows to enjoy the ambiances of various places where music is played. The DSP has six basic presence parameters which can be set individually.

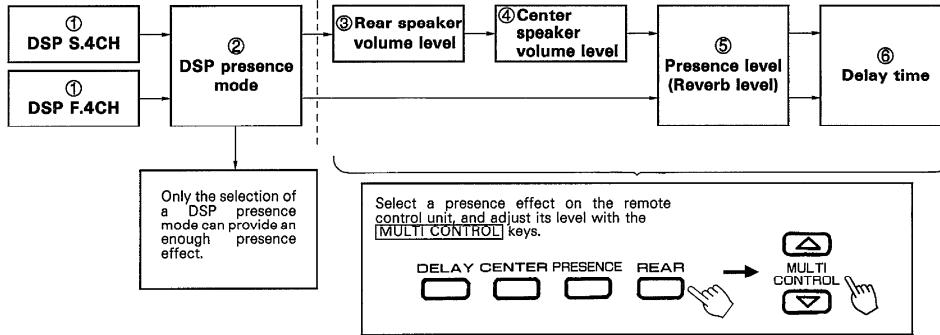

■ DSP presence play

1 Play a music source.

2 Select the DSP mode.

DSP

Each press switches the modes as shown below.

DSP OFF → MOVIE LOGIC → [F.4ch]
DOLBY 3 STEREO → [S.4ch]
DOLBY SURROUND

F.4 CH S.4 CH

Remote control unit

Press repeatedly.

Each press switches the modes as shown below.

ARENA → JAZZ CLUB → STADIUM
MOVIE ← CHURCH ← DISCOTHEQUE

● For the types and effects of the DSP presence modes, please refer to page 56.

3 Select the presence mode.

F.4 CH S.4 CH

Press repeatedly.

Each press switches the modes as shown below.

ARENA → JAZZ CLUB → STADIUM
MOVIE ← CHURCH ← DISCOTHEQUE

● For the types and effects of the DSP presence modes, please refer to page 56.

4 Adjust the rear-speaker volume.
Adjust in the DSP S.4CH mode. **[Remote control only]**

REAR → MULTI CONTROL

5 Adjust the center speaker volume.
Adjust in the DSP S.4CH mode. **[Remote control only]**

CENTER → MULTI CONTROL

Adjust the presence level. [Remote control only]
Adjust to create a desired sound field.

PRESENCE → MULTI CONTROL

Adjust the delay time. [Remote control only]
Adjust to create a desired sound field.

DELAY → MULTI CONTROL

Note:

The presence level and delay time level return to the standard values when the DSP mode or presence mode is changed.

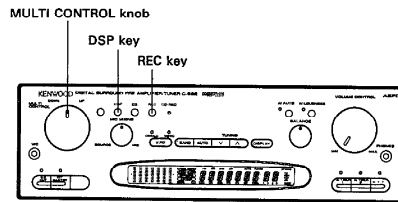

■ To cancel the presence effect

Each press switches the modes as shown below:

DSP OFF → MOVIE LOGIC → F.4ch
 ↑
 DOLBY 3 STEREO → S.4ch
 ↓
 DOLBY SURROUND

Remote control unit

● Be sure to turn the presence effect off when presence playback is not required.

■ To record the presence effect

DSP F.4CH, DSP S.4CH

1 Select a presence sound field.

2 Select the PRESENCE REC mode.

① Press the **REC** key.

REC

② Set the REC mode to PRESENCE.

The PRESENCE REC modes are switched over as shown below:

MULTI CONTROL

DOWN UP

SOURCE
 ↓
 CD REC
 ↓
 PRESENCE

3 Play a music source and record it.

● Set the recording level using the CRLS or CCRS functions.

■ Operation of the ASFC key

Used to adjust the sound expansion when the surround rear speakers and center speaker are not used. **[DSP F.4CH only]**

1 Play a music source.

Refer to steps 1 to 5 of "DSP presence play" on page 54.

2 Adjust the sound expansion.

① Press the ASFC key. **[Remote control only]**

ASFC

② Adjust the level.

MULTI CONTROL

Remote control unit

● The level is variable in the range from 1 to 5.

DSP presence

Type and effect of DSP presence mode	
ARENA	Reproduces the effects of a hall, with long reverberation and much reflection of high-frequency sound.
JAZZ CLUB	Reproduces the feeling of a live jazz house with sounding cymbals.
STADIUM	Reproduces the reflected sound characteristic to stadiums as PA speaker sound to create an excitement-charged atmosphere.
DISCOTHEQUE	Reproduces the feeling of a disco with exciting middle- and high-frequency sounds through the use of moderate reverberation and a graphic equalizer.
CHURCH	Reproduces the rich echoing of a solemn church.
MOVIE	Suppresses reflected sound from the center and reproduces mild echoing from the others.

Delay time [DSP F.4CH, DSP S.4CH]

As shown in the example of illustration, the sound of piano played on the stage attains the ears of listener as a synthesis of the direct sound from piano, the indirect sounds which are reflected once or twice by the reflectors, ceiling and side and back walls, and the reverberation sounds which repeat infinite reflections until they fade out completely.

The indirect sounds always pass through longer routes compared to the direct sound. The delay between the direct and indirect sounds is called the DELAY TIME, and the level of the indirect or reverberated sounds is called the PRESENCE LEVEL. The indirect sounds accompanied with delay play a very important role in providing better sound effects and the feeling of presence of concert halls, etc. The acoustic field also varies depending on the speaker arrangement. It is recommended to try various delay time setting to obtain the best sound field possible.

Example of a concert hall

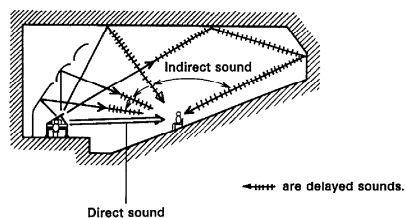

Operation with video components

Please refer to page 12 for the connection of Audio/Visual components.
For the connections and operations, also read carefully the instruction manuals supplied with the video components to be connected.

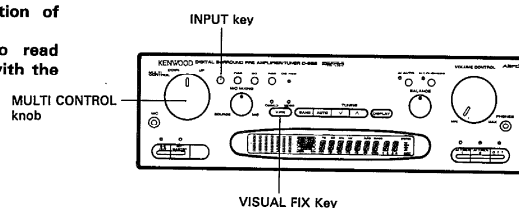

■ Playback of videotape

1 Switch the power of the monitor TV ON.

2 Select the VIDEO input source.

① Set the INPUT mode.



Press the **VIDEO** key.

Proceed to step ② below while the display is showing the input display (about 5 seconds).

② Select the VIDEO input source.

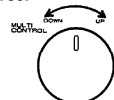

Remote control unit

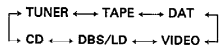

3 Play the VCR.

■ Recording of video source

1 Connect the video component to be recorded.

- A video player deck, video camera, LD player, DBS tuner, etc., can be connected.

2 Select the corresponding input source.

3 Play the video source component.

4 Put the VCR in the record mode.

■ Listening to CD or tape sound while watching video

1 Select the video component the image of which is to be viewed.

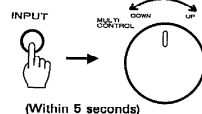

(Within 5 seconds)

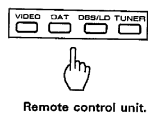

Remote control unit.

2 Press the VISUAL FIX key.



3 Select the audio source to be listened to.

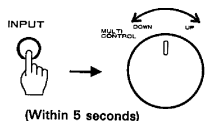

(Within 5 seconds)

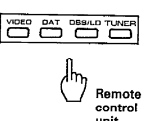

Remote control unit

- Only the audio source is switched over while the image being displayed remains the same.

4 Play the selected video and audio components.

VISUAL FIX key

This function allows to fix the visual-type input (DBS/LD, VIDEO) regardless of the switching of input sources. When VISUAL FIX is ON, the video input image is not changed even when another visual-type input is newly selected. This makes it possible to record the video and audio from different sources.

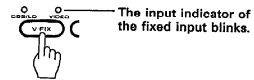

The input indicator of the fixed input blinks.

Press again to cancel.

Operation of timer

Be sure to adjust the present time before proceeding the following.

The timer of the system can be used for the following functions.

- Program timer** : Receives broadcast, records broadcast or plays tape or CD at the specified ON time, and switches power OFF at the specified OFF time. Up to four timer programs can be set. The AI TIMER functions can be added to the program timer function.
- AI TIMER 1** : When the power is switched ON at the timer ON time, the volume will increase in three steps, providing a wake-up effect like an alarm clock.
- AI TIMER 2** : When the power is switched ON at the timer ON time, two tracks of a CD is played first, then the input is switched automatically to the tuner.
- Sleep timer** : Switches power OFF after a set time period has elapsed. If set before you go to bed, power can be switched OFF automatically even after you fell in sleep.
- One-touch timer** : Switches power ON after a specified time period, set in the unit of 30 minutes up to 12 hours, from the moment it is activated. The AI TIMER functions can be added to the one-touch timer function.
- Calendar check** : When the year, month and day are input in this order, the day of the week of that date is displayed by means of an indicator.

- For the timer setting procedures, read description on the next page and after.
- The contents of timer programs can be modified as required.
- Even when a timer program has been input, the timer will not be activated unless its execution has been activated.
- Turn the AI TIMER functions OFF when they are not required; otherwise, they will be added to all of the programs executed on that day.
- Once set, the contents of a program cannot be cleared at once. The previous contents can only be cleared when they are replaced by modification.
- The programs must be set so that their time ranges do not overlap.

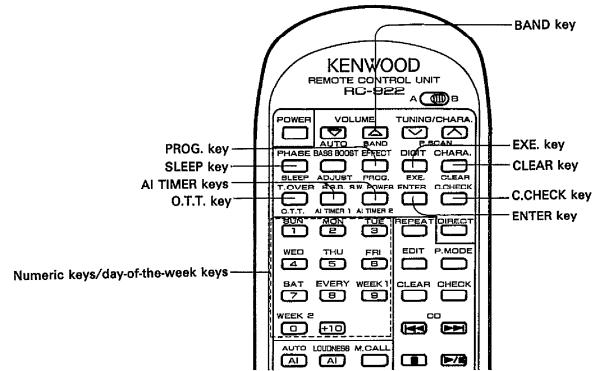

Types of days of the weeks which can be selected by numeric keys

1. To execute a program only once on the specified day of the week after its execution has been activated.

Numeric keys

Sunday	1/SUN
Monday	2/MON
Tuesday	3/TUE
Wednesday	4/WED
Thursday	5/THU
Friday	6/FRI
Saturday	7/SAT

- If it is required to activate the timer in the same time period of the next week, activate the execution again.

2. To execute a program repeatedly on every week after its execution has been activated.

Numeric keys

Every day from Monday to Sunday	8/EVERY
Every day from Monday to Saturday	8/WEEK 1
Every day from Monday to Friday	8/WEEK 2

- If timer operation is not required, cancel the program execution.

Be sure to adjust the present time before proceeding the following.

■Timer reception of radio broadcast Remote control only

1 Switch the power ON.

Press the **[POWER]** key on the power amplifier unit.

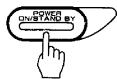

2 Press the PROG. key. SELECT PROGRAM



PNO

- The program No. indicators (1 to 4) blink.

3 Select the program No. to be used.

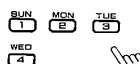

Press within 8 seconds.



Select from 1 to 4.

- The selected program No. indicator blinks.

4 Specify the day(s) of the week with the numeric keys.

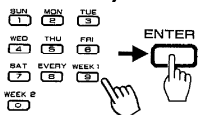

SELECT DAY



SAT

5 Input the ON time with the numeric keys.

6:30AM : 0 6 3 0

INPUT ON TIME



ON 06:30

6 Input the OFF time with the numeric keys.

7:00AM : 0 7 0 0

INPUT OFF TIME



OFF 07:00

7 Select the PLAY mode.

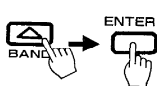

SELECT MODE

MODE-PLAY

The timer modes are switched between PLAY and REC every time the **[BAND]** key is pressed.

8 Select the TUNER source.

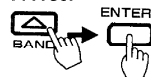

SELECT SOURCE

TUNER

TUNER → CD → TAPE → LAST

The sources are switched every time the **[BAND]** key is pressed.

- "LAST" is to be selected when recording the video of the BS tuner or LD player connected to the preamplifier/tuner unit.

9 Select the preset key under which the station to be received has been preset.

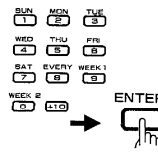

SELECT PRESET

SAT

END

- The radio stations must be preset beforehand.

10 Activate the execution of the program.



SELECT PROGRAM

- ② Select the program No. to be executed by pressing the numeric key under which it is set.

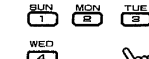

1 9250

- The selected program No. indicator lights up.

11 Adjust the volume and tone.

12 Switch the power OFF.



Press the **[POWER]** key on the power amplifier unit.

To continue the reception of radio station which has been started to be received by timer ON:

- ① Press the **[CLEAR]** key before the OFF time comes.
- ② Press the numeric key for the program No. being executed.

- When the program No. indicator goes off, it means that the program will be received continuously.

Notes:

1. If you commit a mistake in the timer programming, press the **[CLEAR]** key and re-start from the beginning.
2. If it is required to modify a program which has already been set, set a new program from the beginning.
3. When a program has previously been set in the program No. selected in step 3, the newly-set program replaces the previous program.
4. Do not operate the **[CLEAR]** key or **[POWER]** key while the timer program execution has been activated; otherwise malfunction will occur.

Be sure to adjust the present time before proceeding the following.

■ Timer playback of CD **Remote control only**

1 Switch the power ON.

Press the **[POWER]** key on the power amplifier unit.

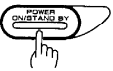

8 Select the CD source.

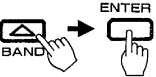

SELECT SOURCE

CD

END

TUNER → CD → TAPE → LAST

The sources are switched every time the **[BAND]** key is pressed.

2 Press the PROG. key.



SELECT PROGRAM

PN0

- The program No. indicators (1 to 4) blink.

9 Place a disc in the CD player.

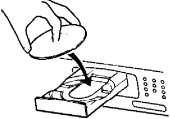

- It is not possible to preset a CD playback programs.

3 Select the program No. to be used.

Press within 8 seconds.

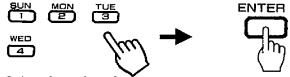

Select from 1 to 4.

- The selected program No. indicator blinks.

10 Activate the execution of the program.

①



SELECT PROGRAM

② Select the program No. to be executed by pressing the numeric key under which it is set.

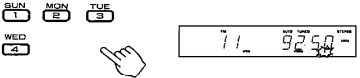

- The selected program No. indicator lights up.

4 Specify the day(s) of the week with the numeric keys.

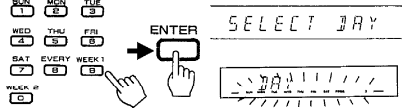

SELECT DAY

MON

11 Adjust the volume and tone.

5 Input the ON time with the numeric keys.

6:30 AM:

0, 6, 3, 0

INPUT ON TIME



ON 06:30

12 Switch the power OFF.

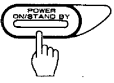

Press the **[POWER]** key on the power amplifier unit.

6 Input the OFF time with the numeric keys.

7:00 AM:

0, 7, 0, 0

INPUT OFF TIME



OFF 07:00

7 Select the PLAY mode.



SELECT MODE

MODE-PLAY-

The timer modes are switched between PLAY and REC every time the **[BAND]** key is pressed.

- Notes:
- If you commit a mistake in the timer programming, press the **[CLEAR]** key and re-start from the beginning.
 - If it is required to modify a program which has already been set, set a new program from the beginning.
 - When a program has previously been set in the program No. selected in step 3, the newly-set program replaces the previous program.
 - Do not operate the **[CLEAR]** key or **[POWER]** key while the timer program execution has been activated; otherwise malfunction will occur.

Be sure to adjust the present time before proceeding the following.

■ Timer playback of tape Remote control only

1 Switch the power ON.

Press the **[POWER]** key on the power amplifier unit.

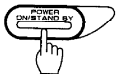

2 Press the PROG. key.



- The program No. indicators (1 to 4) blink.

3 Select the program No. to be used.

Press within 8 seconds.

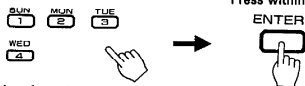

Select from 1 to 4.

- The selected program No. indicator blinks.

4 Specify the day(s) of the week with the numeric keys.

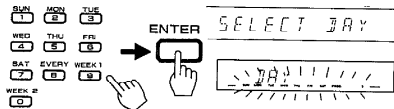

5 Input the ON time with the numeric keys.

6:30 AM:

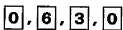

INPUT ON TIME

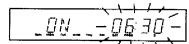

6 Input the OFF time with the numeric keys.

7:00 AM:

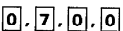

INPUT OFF TIME

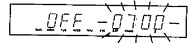

7 Select the PLAY mode.

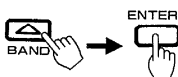

SELECT MODE

MODE-PLAY

The timer modes are switched between PLAY and REC every time the **[BAND]** key is pressed.

8 Select the TAPE source.

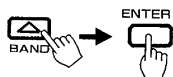

SELECT SOURCE

TAPE

END

TUNER → CD → TAPE → LAST

The sources are switched every time the **[BAND]** key is pressed.

9 Insert a tape and determine the playback condition.

Select the side(s) to be played and the Dolby NR mode.



- Timer playback is possible with either Deck A or Deck B. However, if tapes are placed in decks, playback will begin from Deck B.

10 Activate the execution of the program.



SELECT PROGRAM

- ② Select the program No. to be executed by pressing the numeric key under which it is set.

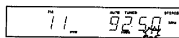
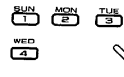

- The selected program No. indicator lights up.

11 Adjust the volume and tone.

12 Switch the power OFF.



Press the **[POWER]** key on the power amplifier unit.

Notes:

1. If you commit a mistake in the timer programming, press the **[CLEAR]** key and re-start from the beginning.
2. If it is required to modify a program which has already been set, set a new program from the beginning.
3. When a program has previously been set in the program No. selected in step 3, the newly-set program replaces the previous program.
4. Do not operate the **[CLEAR]** key or **[POWER]** key while the timer program execution has been activated; otherwise malfunction will occur.

Be sure to adjust the present time before proceeding the following.

■ Timer recording of radio broadcast [Remote control only]

1 Switch the power ON and receive a station to be recorded.

2 Press the PROG. key.

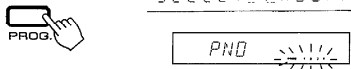

- The program No. indicators (1 to 4) blink.

3 Select the program No. to be used. Press within 8 seconds.

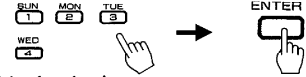

- Select from 1 to 4.
- The selected program No. indicator blinks.

4 Specify the day(s) of the week with the numeric keys.

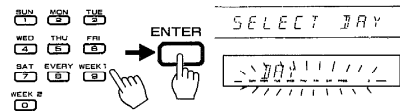

5 Input the ON time with the numeric keys.

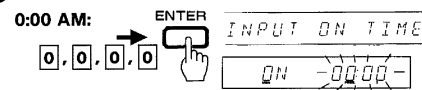

6 Input the OFF time with the numeric keys.

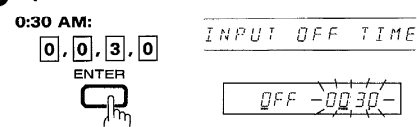

7 Select the REC mode.

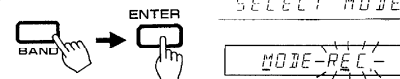

The timer modes are switched between PLAY and REC every time the [BAND] key is pressed.

8 Select the preset key under which the station to be received has been preset.

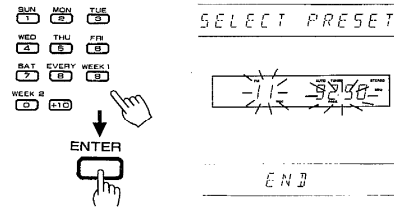

- The radio stations must be preset beforehand.

9 Set up the cassette deck ready for recording.

- 1 Insert a tape in Deck B.
- 2 Set the tape transport direction.
- 3 Select the side(s) to be recorded onto.
- 4 Select the Dolby NR mode.

- The auto-bias adjustment cannot be used.

10 Adjust the recording level.

Press the [CRLS] key.



- It is not necessary to adjust the volume and tone.

11 Activate the execution of the program.



- 2 Select the program No. to be executed by pressing the numeric key under which it is set.



- The selected program No. indicator lights up.

12 Switch the power OFF.

Press the [POWER] key on the power amplifier unit.

Notes:

1. If you commit a mistake in the timer programming, press the [CLEAR] key and re-start from the beginning.
2. If it is required to modify a program which has already been set, set a new program from the beginning.
3. When a program has previously been set in the program No. selected in step 3, the newly-set program replaces the previous program.
4. When the power is tuned ON by the timer, the volume level is automatically set to the lowest level.
5. Do not operate the [CLEAR] key or [POWER] key while the timer program execution has been activated; otherwise malfunction will occur.

Be sure to adjust the present time before proceeding the following.

■ To check timer program contents

1 Press the **PROG.** key.



2 Press the numeric key corresponding to the program to be checked.

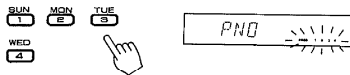

- If no program is selected while the program No. indicators are blinking, the previous display condition resumes.
- When a program is selected, its contents will be displayed for about 3 seconds, and the previous display resumes after it.

■ To cancel timer program execution

1 Press the **CLEAR** key.



2 Press the numeric key corresponding to the program the execution of which is to be cleared.

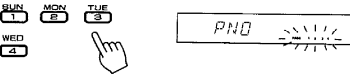

Select the number with a numeric key.

- The program contents are not cleared even when its execution is canceled.

Re-activation of timer execution after canceling it

Since the program itself is retained in memory, check its contents and perform the operation from the step "Activate the execution of the program" as follows.

- 1 Press **EXE.** key.
- 2 Select the program No. to be executed by pressing the numeric key under which it is set.
- 3 Adjust the volume and tone in case of timer reception of broadcast or timer playback of CD or tape.
- 4 Switch the power OFF.

■ Operation of one-touch timer

Press the **O.T.T.** key allows to switch power ON after a specified time period, set in the unit of 30 minutes, from the moment it is activated.

1 Set the timer ON time.

Press the **O.T.T.** key.

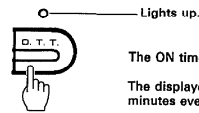

The ON time of the timer is displayed.

The displayed time is incremented by 30 minutes every time the key is pressed.

- When the key is pressed once, a time that can be divided by 30 minutes and within 30 minutes from the present time is displayed as the ON time. (Example: When pressed at 7:40, "8:00" will be displayed.)
- The ON time is incremented in 30-minute steps, for example from 0:00 to 0:30, 1:00, 1:30, and so on.
- The ON time can be set up to 12 hours later.
- The one-touch timer can be set even when the power is OFF.

2 Switch the power OFF.

Press the **POWER** key on the power amplifier unit.



- The ON time can be checked by pressing the **O.T.T.** key once.
- When the power is switched ON, the sleep timer will automatically be set to 60 minutes.
- When the power is switched ON, the last program source (CD, TAPE) will be played.

To cancel one-touch timer activated

Switch the power ON,

or

Press the **O.T.T.** key until the indicator goes off.

Notes:

1. If disc is not present while the CD input is selected or cassette tape is not present while the TAPE input is selected, the last broadcasting station received will be received again.
2. Please note that pressing the **ADJUST** key cancels the one-touch timer.

Operation of timer

When the AI TIMER 1 or 2 key is pressed after the program timer setting has completed, the functions as shown below can be added to the program timer function.

The AI TIMER 1 and AI TIMER 2 do not function in the timer recording mode.

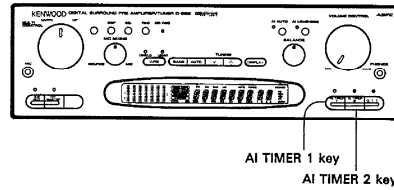

■ Operation of AI TIMER 1

With this function, when the power is switched ON by the program timer, the volume increases in three steps.

1 Complete the program timer setting.

Switch OFF the power on the power amplifier unit.

2 Press the AI TIMER 1 key.

Select the maximum volume.

VOL 1 (Small) → VOL 2 (Medium) → VOL 3 (Large) → OFF (Goes off)

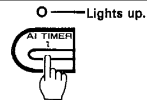

- The maximum volume setting varies every time the key is pressed.

To cancel the execution of AI TIMER 1

Press the AI TIMER 1 key to select OFF.

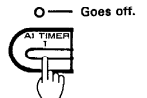

■ Operation of AI TIMER 2

With this function, when the power is turned ON by the program timer, two tracks on a CD are played first, then radio broadcast is received automatically. This function is given precedence to other program timer functions.

1 Place a CD in the CD player.

2 Perform the procedure of "Timer reception of radio broadcast".

- Refer to page 59.

3 Press the AI TIMER 2 key.

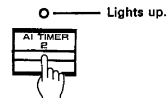

- Also press the AI TIMER 1 key if you want to increase the volume in three steps.

To cancel the execution of AI TIMER 2

Press the key again.

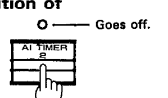

Reference for volume selection

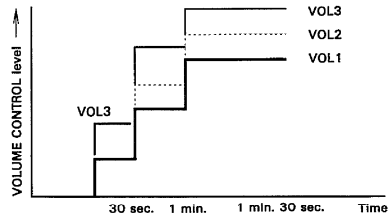

- The VOLUME CONTROL rotates as the volume changes.
- The graphic equalizer curve also varies accordingly.

Notes:

1. When the [MASTER VOLUME] key or [MUTE] key on the remote control unit is operated while the AI TIMER 1 is operated, the volume level is locked.
2. When the select key other than CD is pressed during CD play of AI TIMER 2, the CD stops to play and AI TIMER 2 is canceled.
3. If any of the CD player operation keys is pressed during CD playback based on AI TIMER 2, the AI TIMER 2 operation is released.
4. In case no disc has been placed in the CD player, radio broadcast is received without playing a CD.
5. The AI TIMER 1 and AI TIMER 2 indicators will remain lighted after the operation of the program timer has been completed. Be sure that the AI TIMER indicators are not lighted when not using the AI TIMER function.
6. If the graphic equalizer control key is operated during AI TIMER 1 operation, the AI TIMER does not operate correctly.

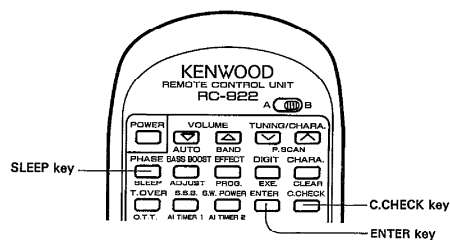

■ Operation of sleep timer

The sleep timer allows to turn the system power off after the specified period has elapsed. This function may be most convenient when you like to fall in sleep while listening to music.

The period can be set up to 90 minutes in 10-minute steps. The sleep timer is applied in priority over other timer programs.

Remote control only

1 Switch the power ON.

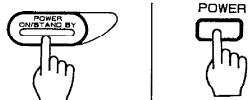

Press the **[POWER]** key on the power amplifier unit.

2 Specify the period after which the power is to be switched OFF.

Press the **[SLEEP]** key.

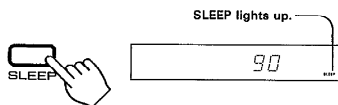

→ 90 → 80 → 70 → 20 → 10 → OFF

- Each press decreases the period by 10 minutes.

To cancel sleep timer

Press the **[SLEEP]** key until the sleep timer is canceled, or
Switch the power OFF.

■ Operation of calendar check

The calendar check allows to display the day of the week of the specified date input by the user in the order of year, month and day. This function covers the range from January 1, 1900 to December 31, 2099.

Remote control only

1 Press the C.CHECK key.



2 Input the year with the numeric keys.

Year 1992: Press **[1][9][9][2]** in this order.

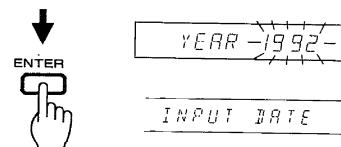

3 Input the month then the day with the numeric keys.

March 30: Press **[0][3][3][0]** in this order.

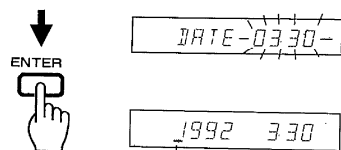

Day of the week

- The day-of-the-week indicator of the date input above lights up. The previous display resumes in a few seconds.

In case of difficulty

What appears to be a malfunction may not always be serious. If your unit should not perform as expected, consult the table below to see if the problem can be corrected before seeking help from your dealer or service representative.

Remote control unit

Symptom	Cause	Remedy
Remote control operation is not possible.	<ul style="list-style-type: none"> Batteries are exhausted. The parallel cord is not connected properly. The remote control unit is too far away from the main system, controlling angle is too large, or there is an obstacle in between. The source component to be operated does not contain the tape(s) or CD. An attempt is made to play a tape which is being recorded in the cassette deck. 	<ul style="list-style-type: none"> Replace with new batteries. Connect properly referring to "System connections". Operate the remote control unit within the controllable range. Place the tape(s) or CD in the source component to be played. Wait until the recording is completed.

Tuner

Symptom	Cause	Remedy
The clock display is blinking without changing from a certain time.	<ul style="list-style-type: none"> There was a power failure. The power cord was unplugged. 	<ul style="list-style-type: none"> Set the current time again. Set the current time again.
The timer does not work.	<ul style="list-style-type: none"> The current time is not set, or there was a power failure. The timer ON time and OFF time have not been set. The timer execution has not been specified. 	<ul style="list-style-type: none"> Set the current time referring to "Time adjustment". Set the timer ON time and OFF time. Specify execution by pressing the [EXE] key.
Radio stations cannot be received.	<ul style="list-style-type: none"> No antenna is connected. The broadcast band is not set properly. The frequency of the desired station is not tuned. 	<ul style="list-style-type: none"> Connect an antenna. Set the broadcast band properly. Tune the frequency of the desired station.
A station which was preset cannot be received by pressing the corresponding numeric key.	<ul style="list-style-type: none"> The preset station belongs to a frequency that cannot be received. The preset memory was cleared because the power cord had been unplugged for a long period of time. 	<ul style="list-style-type: none"> Preset a station with a receivable frequency. Preset the station again.
Interference.	<ul style="list-style-type: none"> Noise due to ignition noise of an automobile. Noise due to an influence from an electric appliance. Noise due to a nearby TV set. 	<ul style="list-style-type: none"> Install the outdoor antenna apart from the road. Turn off the power of the appliance. Install the system more apart from the TV set.

Amplifier and speakers

Symptom	Cause	Remedy
Sound is not output.	<ul style="list-style-type: none"> The speaker cords are disconnected. The volume is set to the minimum position. The [MUTE] key of the remote control unit is set to ON and the point indicator is blinking. The parallel cord is not connected properly. The headphones plug is left inserted in the PHONES jack. 	<ul style="list-style-type: none"> Connect them properly referring to "System connections". Adjust the volume to a proper level. Press the [MUTE] key to OFF. Connect properly referring to "System connections". Remove the plug.
Sound is not output and the POWER indicator on the power amplifier unit is blinking.	<ul style="list-style-type: none"> Speaker cords are short-circuited. The temperature of the unit is abnormally high. 	<ul style="list-style-type: none"> Turn the power off, eliminate the short-circuiting, then turn on the power again. Unplug the power cord, leave the unit until the temperature drops and restart using the system after it.
Sound is not output from one of the speakers.	<ul style="list-style-type: none"> The speaker cord is disconnected. The BALANCE control is set to an extreme position. 	<ul style="list-style-type: none"> Connect it properly referring to "System connections". Adjust the Left/Right balance.
Sound is not output from the Surround rear speaker and/or center speaker, or their sound is very small.	<ul style="list-style-type: none"> The rear-speaker cords and/or center speaker cord are disconnected. The Surround play mode has not been engaged. The REAR level and/or CENTER level controls are set to the minimum level. 	<ul style="list-style-type: none"> Connect them properly referring to "System connections". Set the Dolby Surround or DSP presence mode. Adjust the REAR level and CENTER level controls.

Cassette decks

Symptom	Cause	Remedy
Sounds is not produced when the Play key is pressed.	<ul style="list-style-type: none"> The parallel cord is not connected properly. The head is dirty. Tape is irregularly wound and hard to take up. A non-recorded tape is being played. 	<ul style="list-style-type: none"> Connect properly referring to "System connections". Clean the head referring to "Cleaning the head section". Replace the tape. Play a recorded tape.
The deck does not work when an operation key is pressed.	<ul style="list-style-type: none"> The cassette holder is not closed completely. The operation key was pressed immediately after closing the cassette holder. The operation key was pressed within less than 3 seconds after the power was turned on. Tape is not inserted. Tape is irregularly wound and hard to take up. Tape has been fully wound to reel. 	<ul style="list-style-type: none"> Close the cassette holder completely. Press the desired operation key in a few seconds after closing the cassette holder. Press the desired operation key in more than 3 seconds after turning the power on. Insert a tape. Replace the tape. Change the tape transport direction or insert the tape inversely.
DPSS malfunctions.	<ul style="list-style-type: none"> The tapes not suitable for DPSS operation, for example the spaces between tunes are too short. 	<ul style="list-style-type: none"> Read "DPSS operation".
CCRS does not work.	<ul style="list-style-type: none"> A recordable tape is not inserted in Deck B. A disc is not placed in the CD player. The disc is dirty. 	<ul style="list-style-type: none"> Insert a recordable tape in Deck B and press the CCRS key. Place a disc in the CD player and press the [CCRS] key. Clean the disc, place it in the CD player, and press the [CCRS] key.

In case of difficulty

Symptom	Cause	Remedy
The dubbing on Deck A and Deck B ends at different timing.	<ul style="list-style-type: none"> This is due to the difference in tape length or to the characteristics of the cassette deck mechanisms. 	<ul style="list-style-type: none"> A small time difference is not regarded as a failure.
The cassette holder does not open when the Eject key is pressed.	<ul style="list-style-type: none"> The key is pressed during recording or playback. 	<ul style="list-style-type: none"> Press in the Stop mode.
Sound is hoarse, or high frequencies are not audible.	<ul style="list-style-type: none"> The head is dirty. The tape is stretched or wrinkled. 	<ul style="list-style-type: none"> Clean the head referring to "Cleaning the head section". Replace the tape.
Sound is distorted.	<ul style="list-style-type: none"> The recording level has not been set by the [CRLS] key. A tape recorded with distorted sound is being played. 	<ul style="list-style-type: none"> Adjust the recording level referring to "Recording operation on cassette deck". Replace the tape.
Recording is not initiated when the Recording key is pressed.	<ul style="list-style-type: none"> The protection tab on the cassette has been broken. The cassette holder is not closed completely. The TAPE input selector is selected on the preamplifier/tuner. Tape has been fully wound to a reel. 	<ul style="list-style-type: none"> Use a cassette with unbroken tab. or close the hole. Close the cassette holder completely. Press the input select key of the source to be recorded. Change the tape transport direction of Deck B or insert the tape inversely.
Noise level is high.	<ul style="list-style-type: none"> The head is magnetized. External noise is induced. A tape recorded with Dolby NR ON is being played with Dolby NR OFF. 	<ul style="list-style-type: none"> Demagnetize the head referring to "Cleaning the head section". Install the system apart from other electrical appliances and TV set. Press the [DOLBY NR] switch to B or C.
Sound is vibrating.	<ul style="list-style-type: none"> The capstans or pinch rollers are dirty. Tape is irregularly wound. 	<ul style="list-style-type: none"> Clean the head referring to "Cleaning the head section". Wind the tape regularly by fast forwarding, rewinding or playing it fully from one reel to another.

CD player

Symptom	Cause	Remedy
Disc has been placed but it cannot be played.	<ul style="list-style-type: none"> The disc is placed upside down. The disc is displaced. The disc is very dirty. The disc is scratched or damaged. Dew is condensed on the optics lenses. 	<ul style="list-style-type: none"> Place the disc properly, with the labeled side up. Remove the disc and place it on the correct position. Clean the disc then play it again. Replace the disc. Remove condensed dew by referring to "Beware of condensation".
Sound is not produced.	<ul style="list-style-type: none"> Disc is not placed. The CD player is not set in the play mode. The disc is displaced. The disc is scratched or damaged. The parallel cord is not connected properly. 	<ul style="list-style-type: none"> Place a disc and play it. Press the play/pause key. Remove the disc and place it on the correct position. Replace the disc. Connect properly referring to "System connections".
Sound skips.	<ul style="list-style-type: none"> The disc is dirty. The disc is scratched or damaged. Vibrations are applied to the CD player. 	<ul style="list-style-type: none"> Clean the disc then play it again. Replace the disc. Install the system in a place which is not subject to vibrations.

Notes:

- With some tapes, a squeaky noise is produced when the tape is stopped automatically. This is due to the tape protection function, and not a malfunction.
- Do not use 120-minute tapes, for the tape is too thin and gets easily tangled.
- This system is microprocessor-controlled, so malfunction may occur due to external noise or interference noise. In such a case, unplug the power cord, plug it and turn power on again.
- Do not use contact cleaners because it could cause a malfunction. Be specially careful against contact cleaners containing oil, for they may deform the plastic components.

When your unit needs to be repaired, bring the entire set (Speakers excluded) to your dealer.

**For CANADA
DOC REGULATION**

"This digital apparatus does not exceed the CLASS B limits for radio noise emissions from digital apparatus as set out in the radio interference regulations of the Canadian Department of Communications."

**For the U.S.A.
FCC WARNING:**

This equipment may generate or use radio frequency energy. Changes or modifications to this equipment may cause harmful interference unless the modifications are expressly approved in the instruction manual. The user could lose the authority to operate this equipment if an unauthorized change or modification is made.

NOTE:

This equipment has been tested and found to comply with the limits for a Class B digital device, pursuant to Part 15 of the FCC Rules. These limits are designed to provide reasonable protection against harmful interference in residential installation. This equipment may cause harmful interference to radio communications, if it is not installed and used in accordance with the instructions. However, there is no guarantee that interference will not occur in a particular installation. If this equipment does cause harmful interference to radio or television reception, which can be determined by turning the equipment off and on, the user is encouraged to try to correct the interference by one or more of the following measures:

- Reorient or relocate the receiving antenna.
- Increase the separation between the equipment and receiver.
- Connect the equipment into an outlet on a circuit different from that to which the receiver is connected.
- Consult the dealer or an experienced radio/TV technician for help.

Strömbrytarens POWER beredskapsläge

Indikatorn STAND BY tänds efter nätkabelns anslutning till ett vägguttag, oavsett strömbrytarens POWER till/frånslag. Detta anger att en liten mängd ström leds till komponenten som stöd för minnesinnehållet.

Detta läge kallas för beredskapsläget. Strömbrytaren på fjärrkontrollen kan användas för att slå på och av strömmen så länge indikatorn STAND BY lyser.

Virtanäppäimen (POWER) valmiustila (STAND BY)

Kun laitteen verkkojohto on liitetty pistorasiaan, valmiustilan merkkivalo syttyy riippumatta virtanäppäimen (POWER) asennosta (ON/OFF). Merkkivalo osoittaa, että laitteessa on hieman virtaa muistin sisältöjen ylläpitoa varten. Tätä tilaa kutsutaan valmiustilaksi. Kun valmiustilan merkkivalo (STAND BY) palaa, laitteen virta voidaan kytkeä ja katkaista kaukosäätimellä.

Afbrydertastens (POWER) STAND BY funktion

Når apparatets strømledning er tilsluttet en stikkontakt, lyser STAND BY indikatoren, uanset om der er tændt ved afbryderen på apparatet eller ej. Det angiver, at apparatet bliver forsynet med en ganske lille mængde strøm til opretholdelse af hukommelsens indhold.

Denne funktion kaldes STAND BY. Når STAND BY indikatoren er tændt, kan strømmen til apparatet slås til og fra med fjernsty-ringsenheden.

PÅ/AV-knappens Stand-by funksjon

Når strømledningen til dette anlegget er satt i en vekselstrømskontakt, vil STAND-BY indikatorlampen lyse enten PÅ/AV-knappen er på- eller avslått. Dette betyr at en viss mengde strøm tilløres anlegget slik at innholdet i minnet ikke går tapt. Denne funksjonen kalles Stand-by. Når indikatorlampen for STAND-BY er tont, kan strømmen slås PÅ/AV fra fjernkontrollen.

Specifications (For U.K. and Europe)

Pre Amplifier/Tuner unit (C-922L)

FM Tuner section

Tuning frequency range 87.5 MHz ~ 108 MHz
Sensitivity (DIN at 75 Ω)

MONO 2.0 μV/17.5 dBf

Total harmonic distortion

(DIN at 1 kHz, 65.2 dBf input)

MONO 0.5%

STEREO 0.6%

Signal to noise ratio

(DIN weighted at 1 kHz, 65.2 dBf input)

MONO 75 dB

STEREO 66 dB

Selectivity (DIN ±300 kHz) 60 dB

Stereo separation (DIN at 1 kHz) 40 dB

Frequency response 30 Hz ~ 15 kHz +1 dB,
-3 dB

MW Tuner section

Tuning frequency range 531 kHz ~ 1,602 kHz

Usable sensitivity 20 μV/(500 μV/m)

Signal to noise ratio 48 dB

LW Tuner section

Tuning frequency range 153 kHz ~ 281 kHz

Usable sensitivity 32 μV (1600 μV/m)

Signal to noise ratio 40 dB

Pre Amplifier section

Rated output voltage (PRE OUT)

..... 1.0 V (20 Hz ~ 20 kHz, 0.03%)

Total harmonic distortion

..... 0.03% (20 Hz ~ 20 kHz)

..... 0.01% (1 kHz)

Frequency response

..... 5 Hz ~ 50 kHz, +0 dB, -3 dB

Signal to noise ratio

..... 89 dB (IHF'66)/84 dB (IHF'78)

Input sensitivity/Impedance

DAT, DBS/LD, VIDEO 150 mV/47 kΩ

MIC 1.5 mV/47 kΩ

AI Loudness control

VOLUME at -30 dB level +5 dB (100 Hz)
+4 dB (10 kHz)

Output level/Impedance

DAT, VIDEO 150 mV/2.2 kΩ

Graphic equalizer

Individual channel 60 Hz, 150 Hz, 400 Hz,
1 kHz, 2.5 kHz, 6 kHz, 15 kHz

VIDEO section

Input level/Impedance

VIDEO (composite) 1 Vp-p/75 Ω
Input (DBS/LD, VIDEO IN)

Output level/Impedance

VIDEO (composite) 1 Vp-p/75 Ω
Output (MONITOR OUT, VIDEO OUT)

[General]

Power consumption AC 20 V, 1 A/AC 10 V, 700 mA

Dimensions W: 270 mm (10-5/8")
H: 85 mm (3-3/8")
D: 331 mm (13-1/16")

Weight (net) 3.4 kg (7.5 lb)

Power Amplifier unit (B-922)

Rated power output

(IEC/NF)

From 63 Hz to 400 Hz, 0.7% T.H.D.

[LOW] 35 W + 35 W (at 8 Ω)

..... 40 W + 40 W (at 6 Ω)

From 400 Hz to 12,500 Hz, 0.7% T.H.D.

[HIGH] 20 W + 20 W (at 8 Ω)

..... 25 W + 25 W (at 6 Ω)

(DIN)

1 kHz at 8 Ω 35 W + 35 W (LOW)

..... 20 W + 20 W (HIGH)

1 kHz at 6 Ω 40 W + 40 W (LOW)

..... 25 W + 25 W (HIGH)

Presence

1 kHz at 8 Ω 20 W + 20 W

Total harmonic distortion

..... 0.08% (40 Hz ~ 20 kHz Rated power 6 Ω)

..... 0.005% (1 kHz, Rated power 6 Ω)

Frequency response

..... 40 Hz ~ 70 kHz, +0 dB, -3 dB

Signal to noise ratio

..... 105 dB (IHF'66)/90 dB (IHF'78)

N.B. circuit (-30 dB Volume level) +13 dB
(at 60 Hz)

[General]

Power consumption 190 W

Dimensions W: 270 mm (10-5/8")

H: 120 mm (4-3/4")

D: 330 mm (13")

Weight (net) 7.8 kg (17.2 lb)

Note:

KENWOOD follows a policy of continuous advancements in development. For this reason specifications may be changed without notice.

Cassette deck unit (X-722)

Type 4-track, 2-channel stereo
Recording system AC bias system
(Frequency: 105 kHz)
Heads
A deck Playback head 1
B deck Playback/Record head 1
Erasing head 1
Motors
A deck 1
B deck 1
Fast winding time Approx. 105 seconds
(C-60 tape)
Frequency response
Normal tape 35 Hz to 17,000 Hz ± 3 dB
CrO₂ tape 35 Hz to 18,000 Hz ± 3 dB
Metal tape 35 Hz to 18,000 Hz ± 3 dB
Signal to noise ratio
Dolby C NR ON 74 dB (Metal tape)
Dolby B NR ON 66 dB (Metal tape)
Dolby NR OFF 58 dB (Metal tape)
Harmonic distortion Less than 0.9%
(at 1 kHz, 3rd H.D., Metal tape)
Wow and flutter 0.08% (W.R.M.S.)
 $\pm 0.18\%$ (DIN)

[General]

Power consumption AC 14 V, 1 A
Dimensions W: 270 mm (10-5/8")
H: 120 mm (4-3/4")
D: 259 mm (10-3/16")
Weight (net) 2.8 kg (6.2 lb)

CD player unit (DP-722)

Laser Semiconductor laser
Playing rotation 200 rpm ~ 500 rpm (CLV)
Frequency response 20 Hz ~ 20 kHz, ± 1.0 dB
Signal to noise ratio More than 93 dB
Total harmonic distortion
..... Less than 0.015% (at 1 kHz)
Channel separation More than 85 dB (at 1 kHz)
Wow & Flutter Unmeasurable Limit
Optical output -15 dBm ~ -21 dBm
(Wave length 660 nm)

[General]

Power consumption AC 9 V, 0.9 A
Dimensions W: 270 mm (10-5/8")
H: 85 mm (3-3/8")
D: 255 mm (10-1/16")
Weight (net) 2.0 kg (4.4 lb)

Speakers (LS-922)

Enclosure Bass-reflex type
Speaker configuration 3-Way system
Woofers 165 mm, cone type
Midrange 100 mm, cone type
Tweeter 25 mm, dome type
Presence speaker 100 mm, cone type
Impedance
LOW INPUT 6 Ω
HIGH INPUT 6 Ω
PRESENCE INPUT 8 Ω
Maximum input level
LOW INPUT 80 W
HIGH INPUT 40 W
PRESENCE INPUT 30 W
Frequency response
LOW INPUT 40 Hz ~ 6.500 Hz
HIGH INPUT 170 Hz ~ 22 kHz
PRESENCE INPUT 150 Hz ~ 16 kHz

[General]

Dimensions W: 230 mm (9-1/16")
H: 410 mm (16-1/8")
D: 291 mm (11-7/16")
Weight (net) 9.0 kg (19.8 lb) (1 piece)

Note:

KENWOOD follows a policy of continuous advancements in development. For this reason specifications may be changed without notice.